

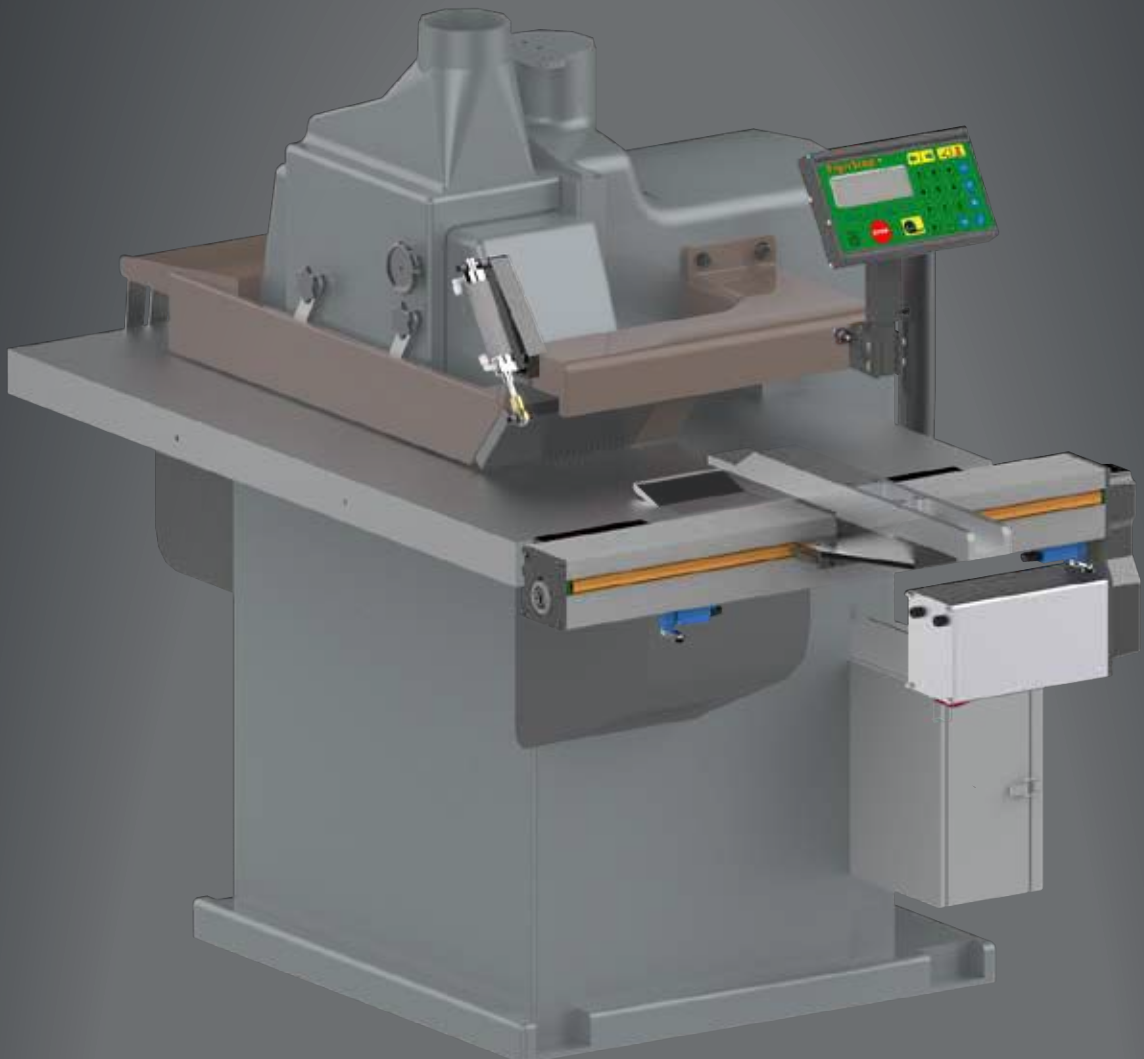

# Installation Guide

**TigerStop®**  
fast and accurate...every time

# TigerFence SLR



# Serial Number

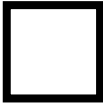

Controller

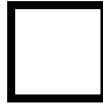

Controller Stand

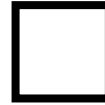

Mounting Brackets



Controller Cable

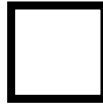

Solenoid Cable



Power Cable



Regulator

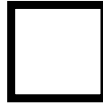
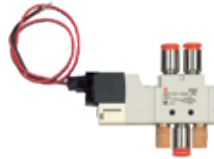

Solenoid Valve



Pneumatic Tubing

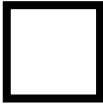

Nut Pack

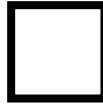

Quick Reference Cards

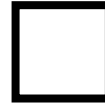

Nut Pack

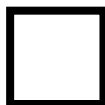

Pneumatic Kit



Drilling Template

# Safety First!

IMPORTANT SAFETY INFORMATION. READ ALL WARNINGS BEFORE OPERATING THIS PRODUCT.



## GENERAL WARNINGS

WARNING: Installation of your TigerStop Product must be done by a person trained in the safe design and installation of automation products, and in the safe operation of power equipment. Ensure that such installation meets all legally required safety requirements and guidelines, and that proper guarding and safety devices are provided on all sides of the equipment to preclude unintended access during operation. Consult with and follow the recommendations of a qualified safety engineer.

WARNING: TigerStop Products are components intended for use in conjunction with potentially dangerous machinery. The use of TigerStop Products does not make other machinery safe. TigerStop Products are not intended to substitute, in any manner, for safe operating practices in general, or for safety features present in other machines designed to make those machines as safe as possible. **TIGERSTOP PRODUCTS, IF USED OR INSTALLED IMPROPERLY, MAY CAUSE PERSONAL INJURY OR DEATH AND SHOULD ONLY BE OPERATED BY PERSONS TRAINED IN THEIR SAFE OPERATING PROCEDURES.** Illustrations of TigerStop Products in use do not show, and are not intended to show, all safety features and practices necessary for their safe operation.



## INSTALLATION WARNINGS

WARNING: TigerStop Products must be installed in accordance with all local, state, and federal regulations. Only personnel properly trained in the safe design and installation of automation machinery and related power equipment should install TigerStop Products onto other equipment, to ensure a safe and proper work station. TigerStop Products should not be operated without proper training, both in the operation of TigerStop Products, and in the operation of related equipment.

### IMPORTANT CAUTION:

The motor box (compartment) contains DC voltage with potentially FATAL amperage. NEVER attempt any unauthorized actions inside the motor box.



## INTERCONNECTS

WARNING: Using a TigerStop interconnect does not relieve you of the responsibility for making sure that your saw or other tool has all the necessary safety equipment in place. All installations must meet all legally required safety requirements and guidelines. Installation and training should be done following the recommendations of a qualified safety engineer.

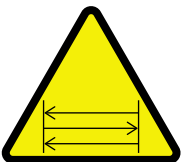

## OPERATION

DANGER: This machine can start, move and stop automatically. Keep hands and loose clothing clear of moving parts while operating. Moving parts can crush and cut. When used with a saw or other cutting equipment, bodily injury and death may result if operated without safety guards on all machines. Do not operate with guards removed. Operators must wear adequate eye and ear protection.



DANGER! Don't get pinched by the push feeder. Keep your hands away when in motion!

**IMPORTANT SAFETY INFORMATION. READ ALL WARNINGS BEFORE OPERATING THIS PRODUCT.**



Keep the work area clean and well lighted to avoid accidental injury.

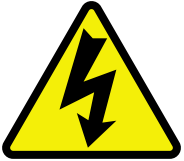

Do not use TigerStop machines in a dangerous environment. Using power tools in damp or wet locations or in rain can cause shock or electrocution.



Do not operate near flammable liquids or in gaseous or explosive atmospheres!



Wear proper apparel, no loose clothes, long hair or jewelry which could get pulled into moving machinery or materials.  
Wear non slip footwear, safety glasses, ear protection and a dust mask.



Use only 3- wire extension cords that have 3-prong grounding type plugs and 3-pole receptacles that accept the tools plug for 120VAC. Use only 5-wire cords and plugs when using 3 phase.



Do not open motor compartment or controller keypad. DC Voltage with potentially FATAL amperage!  
Disconnect power before servicing. No user-serviceable parts inside.

DO NOT operate this or any machine under the influence of drugs or alcohol!



No one should operate this machine except for fully qualified personnel.  
Read the manual!

# Table of Contents

- Installation Requirements.....6
- TigerFence SLR Installation.....7
- Enable Code.....14
- First Power Up.....15
  - Find the End Limits
  - Auto Detect
  - Calibrate
  - Set Kerf
  - Set Units
  - Set Optimizer Settings
- Basic TigerFence Functions.....20
  - Entering Decimals
  - Entering Fractions
  - Calculator Mode
  - Jog
  - Increment
  - PreSet
  - Quick Calibration
- Working with Part Lists.....24
- Maintenance Schedule.....27

# Installation Requirements

## TigerFence SLR Power Requirements

110 VAC	15 Amps
208 VAC	20 Amps
240 VAC	20 Amps

TigerFence SLR must have a dedicated circuit. No other equipment should be on the same circuit.

**WARNING!** Do NOT use a high leg delta circuit to power TigerFence SLR. If you are not sure what kind of circuit you are using, STOP! Have a qualified electrician confirm the main power circuit.

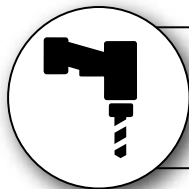

### Do **NOT** drill or tap into the TigerStop beam!

Drilling holes into the TigerStop beam may damage the drive system. All fastening or attachment to the fence beam must be made by inserting T-bolts or T-nuts with washers.

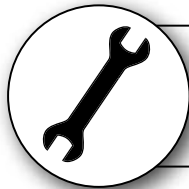

### Do **NOT** over tighten mounting hardware!

It is critical, especially if not using the TigerStop Universal Attachment brackets, that the bolts are prevented from over tightening and driving into the fence beam. Always use washers.



### **ALWAYS** evenly tighten mounting hardware!

Uneven tightening of mounting hardware can introduce a slight twist or other deformation in the beam. This will result in inaccurate measurement and premature failure of the drive belt or other components.

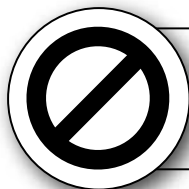

### **NEVER** open TigerStop Motor Box!

The motor box compartment contains DC voltage with potentially FATAL amperage. NEVER attempt unauthorized actions inside the motor box!

# TigerFence SLR Installation



**WARNING!** Read all instructions before performing installation! **NEVER** power up system while motor box is open! **ALWAYS** lock out/tag out TigerStop machinery before installing!

**WARNING!**

## TigerFence SLR Anatomy

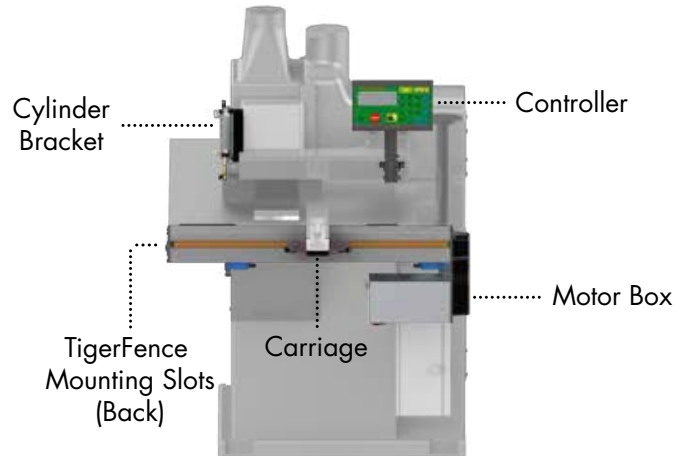

## Mount TigerFence to Saw

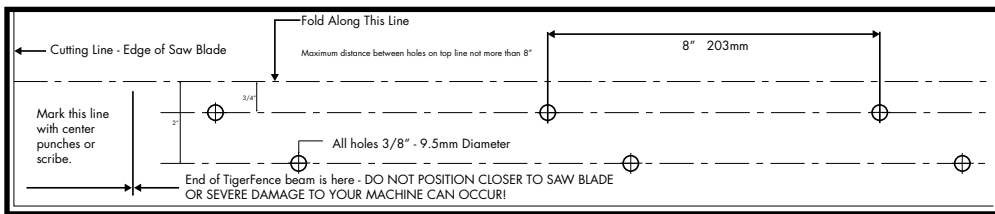

TigerFence Drilling Template  
(Shipped in cardboard tube)

1. Remove the existing rip fence from the saw.  
**Note:** Set the fence and fence mounting bolts aside to be used later.

2. Lay the drilling template over the saw table and drill the mounting holes into the saw table and the spacer blocks, as shown on the template.

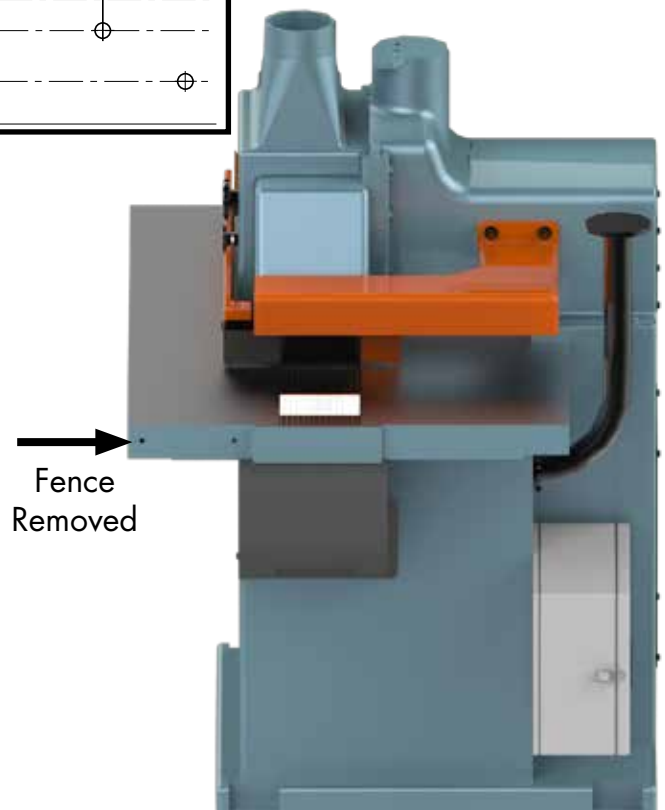

3. Attach TigerFence SLR to the table using the spacers and supplied hardware.

Note: Ensure the TigerFence SLR is flush with the saw table top.

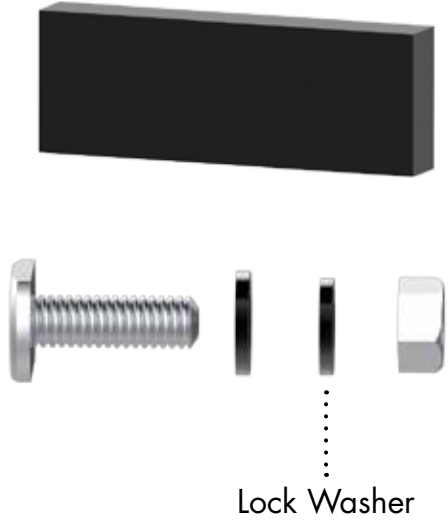
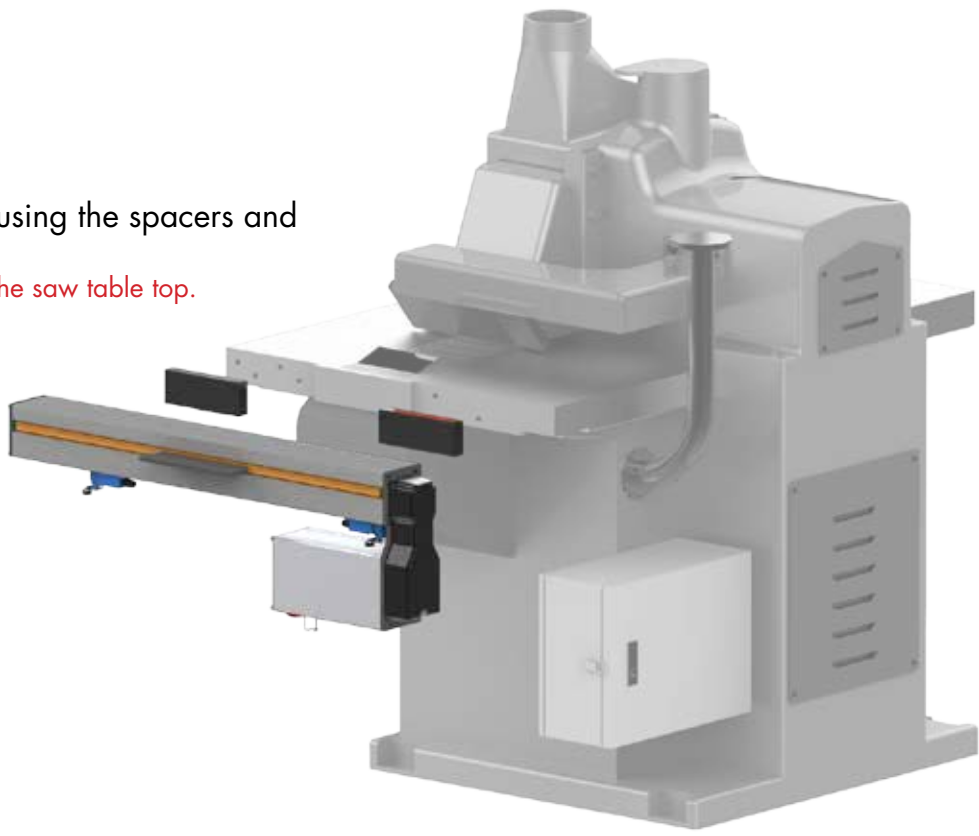

### Mount Fence to TigerFence

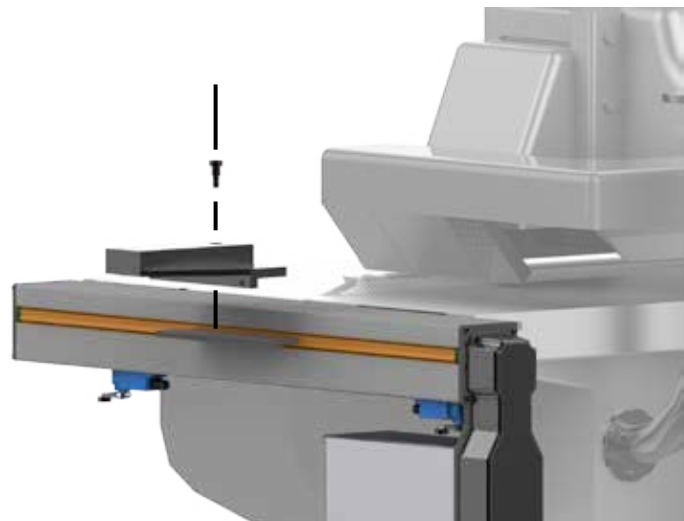
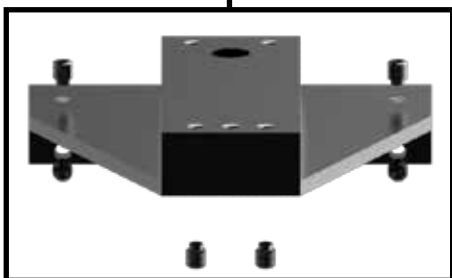
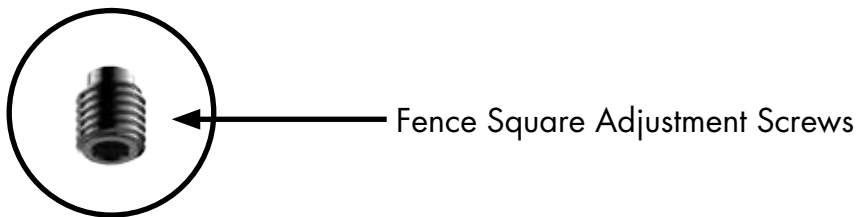



4. Attach your existing ripping fence to the TigerFence SLR fence bracket.  
*Note: You may need to drill the existing rip fence.*

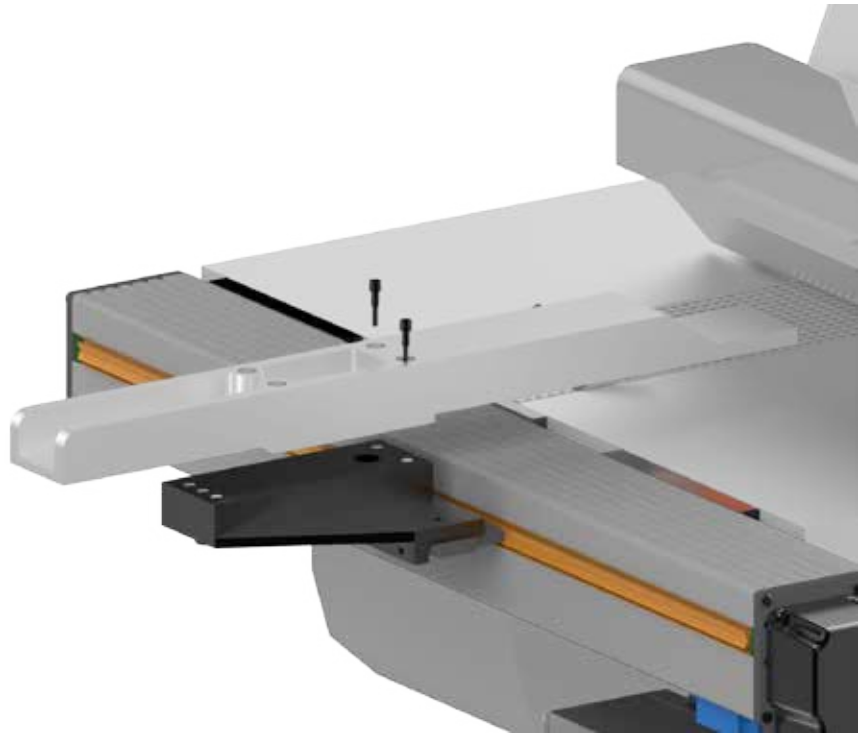

### Mount Anti-Kickback Teeth Control

Drill & Tap

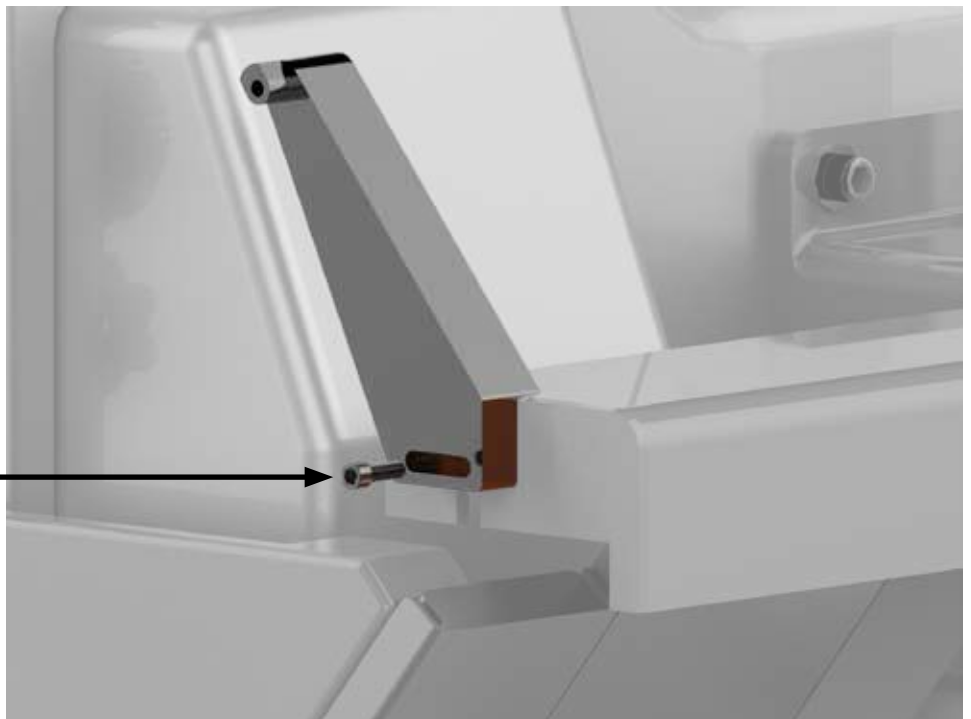

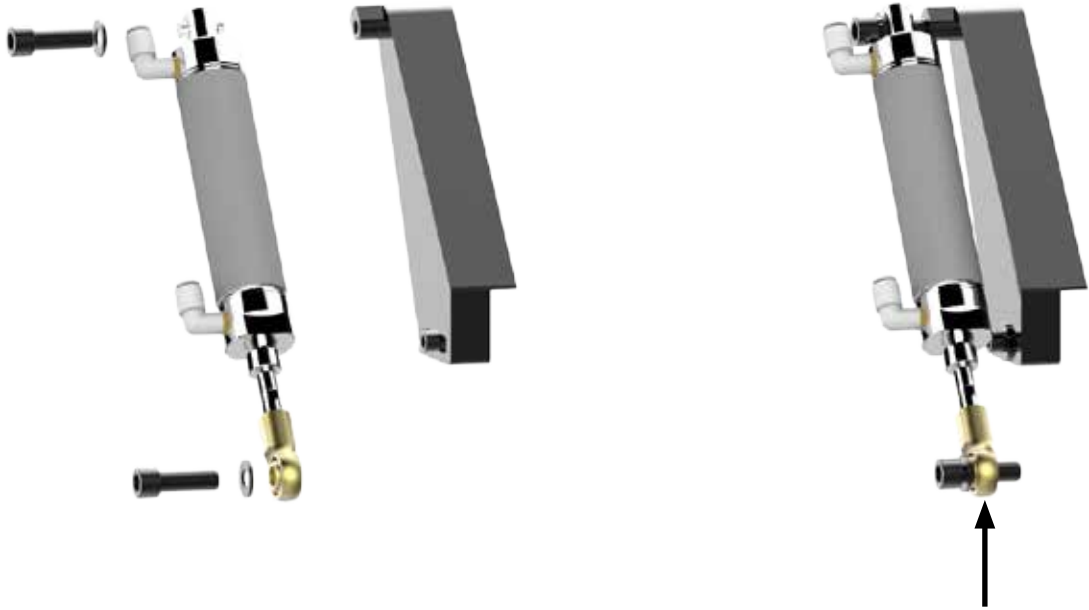

Connect to anti kick back lever



## Plumb Pneumatics

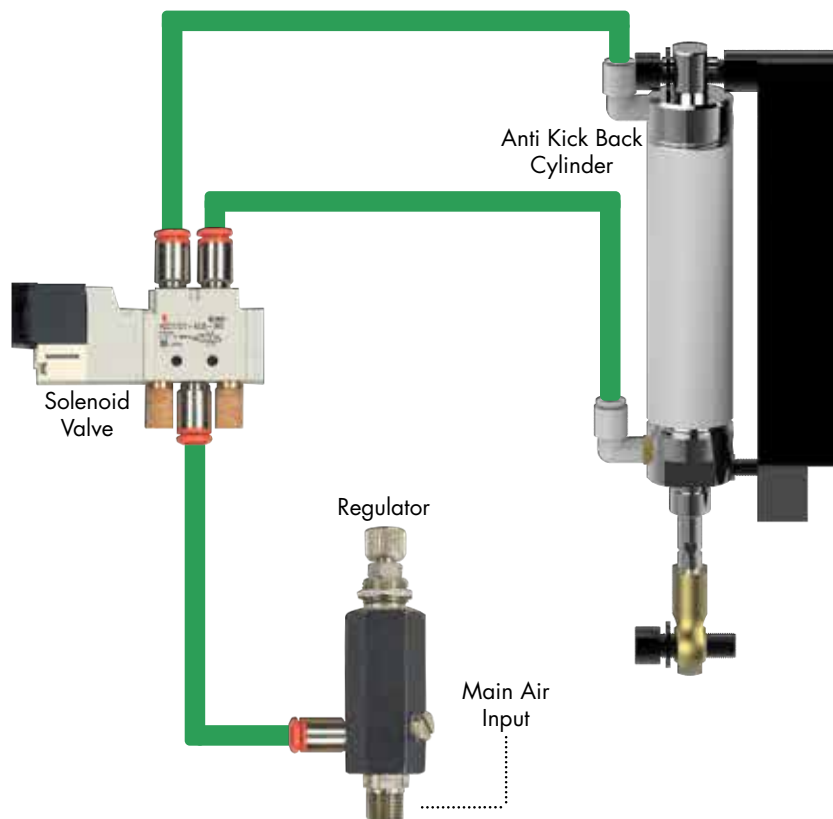

**Install Controller Stand**

1.



2.

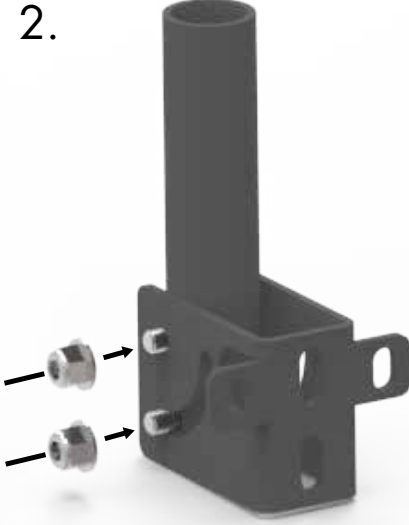

3.

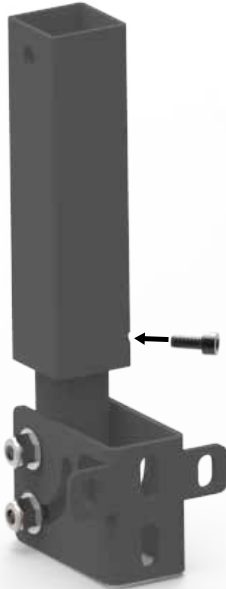

4.



5.



6.



7.



8.



9.



Note: Attach the controller stand anywhere that is convenient for the machine operator.

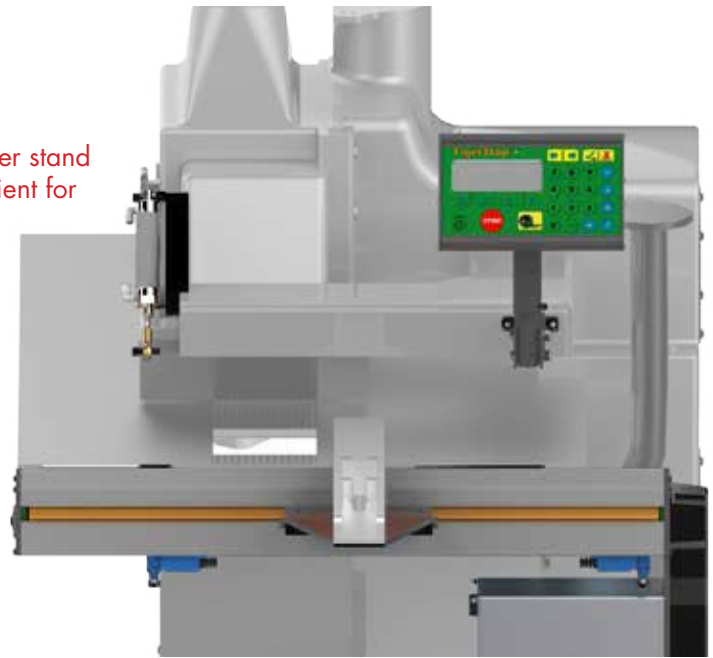

### Set Range of Movement by Adjusting End Sensors

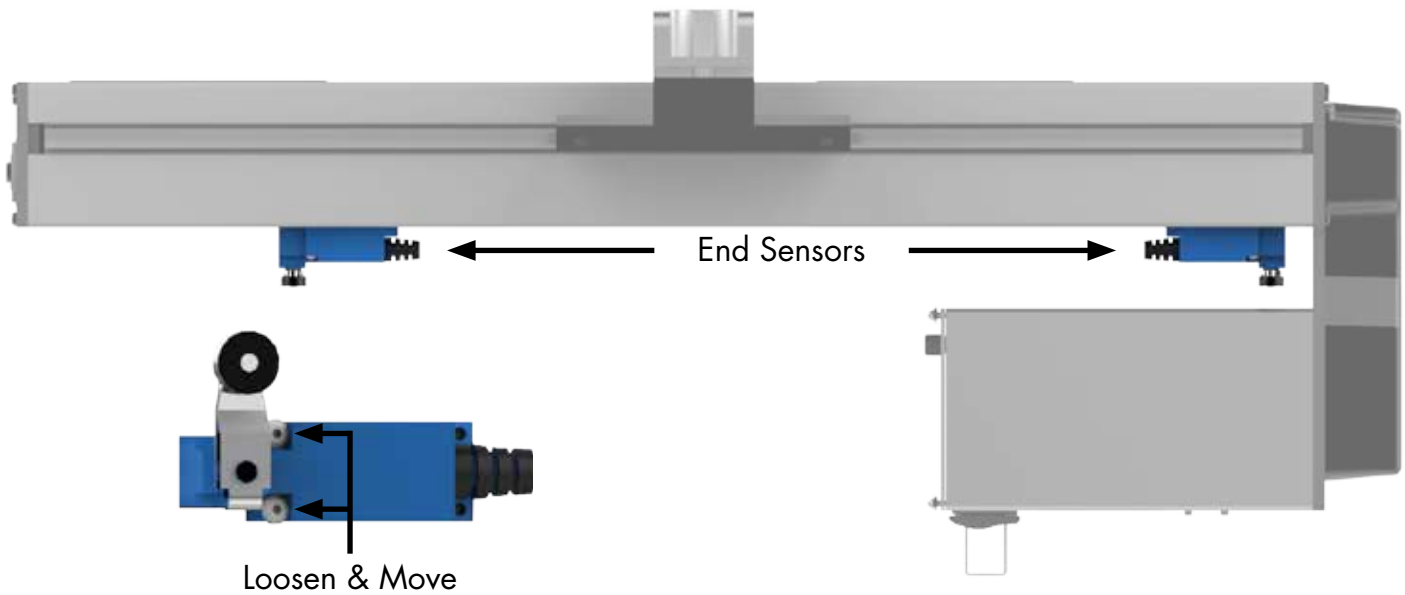

# Final Connections



**Controller**



**TigerStop Motor Box**

White End (Motor Box)  
Black End (Controller)

**Controller Cable**



**15 Pin**



**Solenoid**



**TigerStop Motor Box**

Solenoid Cable



**6 Pin**



**Power Outlet**



**TigerStop Motor Box**

Black TigerStop  
Power Cable



**Power Cable**

# Enable Code

Your new TigerFence will not function until you enter the TigerStop enable code, which is supplied by TigerStop Customer Service.

The enable code notifies TigerStop, LLC when your new TigerFence is about to be put into service. This lets us start the warranty on the exact day you turn it on. The enable code also allows TigerStop to turn on your TigerStop Dynamic Optimization upgrade.

## How to Enable TigerStop

1. Fill out the TigerStop Warranty Registration sheet that is shipped with your TigerFence controller.

Fax or email the registration to;

(360) 260-0755  
service@tigerstop.com

You may also register your warranty by phone;

**TigerStop Customer Service**  
(360) 254-0661

TigerStop Customer Service will contact you by phone to give you the enable code, within the hour during regular business hours, Monday through Friday 6:00 am - 4:00 pm PST.

2. When you have received your enable code, power up TigerFence using the power switch on the motor box.
3. TigerFence will ask you to enter your enable code. Enter the code and press .

Your TigerFence has now been enabled.

TigerStop Warranty Registration	
Please fill in your company information and fax this to TigerStop at (360) 260-0755. Your machine warranty begins on the date that you receive your enable code.	
<b>Serial Number:</b> _____	
<b>Company Information</b>	
Name of Company _____	Email Address _____
What is the street address of the TigerStop? _____	<small>PLEASE PRINT AND USE ALL CAPS FOR YOUR BUSINESS. Please provide your email address so we can send you important notices. Please do not put your name on this form. Send to customer.service@tigerstop.com. <a href="http://www.tigerstop.com">www.tigerstop.com</a></small>
Contact Name _____	<input type="checkbox"/> Please call me with an enable code also.
Tel _____	
Fax _____	
<b>3. Please select your industry</b>	
Furniture Manufacturing _____	Wood Industry _____
Kitchen & Bath Cabinetry _____	Mouldings & Millwork _____
Commercial Fixtures _____	Wood Doors & Windows _____
Doors & Windows _____	Lumber & Panel Products _____
Sheet Metal Fabrication _____	Metal Industry _____
Other _____	Other _____
Plastic Industry _____	Other _____
<b>4. What problem(s) did you purchase the TigerStop to solve?</b>	
Eliminate Setup _____	Improve Accuracy _____
Increase Productivity _____	Improve Material Costs / Optimization _____
Reduce Labor Costs _____	Eliminate Rework _____
Reduce Waste _____	Increase Reliability _____
<b>5. Where did you first hear about TigerStop?</b>	
Word of mouth _____	Used in a different job _____
Trade Show _____	Dealer recommendation _____
Internet Search _____	Mobile Showroom _____
Reading user _____	E-mail _____
<b>6. This TigerStop is being used with (check one)</b>	
Saw: Chop Saw _____	Blind Machines _____
Saw: Double Miter _____	Drill Press _____
Saw: Miter _____	Mounter _____
Saw: Radial Arm _____	Top Workbench _____
Saw: Straightline Rip _____	Punch Press _____
Saw: Table _____	Shears _____
Saw: Up Cut _____	Tube Bending _____
Saw _____	Tube Cutter _____
Custom Machinery _____	Other _____

## Enabling Dynamic Optimization

The Dynamic Optimization enable code upgrade is necessary to use TigerFence to its fullest potential. TigerFence can run an optimizing algorithm that will find the mathematically perfect way to cut your material. This can decrease material waste by up to 40%.

**Ask TigerStop Customer Service about Dynamic Optimization!**

# First Power Up

After entering the enable code, TigerFence will ask to run the 'Home Routine'.

## Home Routine Explained

Every time TigerFence is powered up, it performs the 'Home Routine'. The home routine is a 3 step process where TigerFence will move to its farthest possible position.

**START**

1. Press **START** to run the Home Routine.
2. When movement stops, TigerStop will display the Ready Screen.

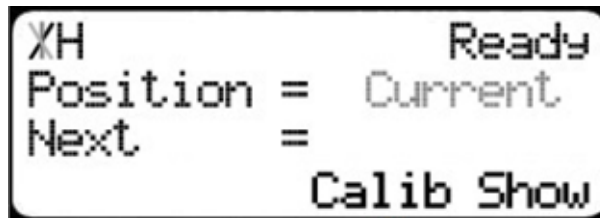

```
XH Ready
Position = Current
Next =
Calib Show
```

The Ready Screen is the starting point for all TigerStop functions. Let's take a look at the screen, line by line.

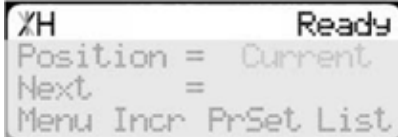

```
XH Ready
Position = Current
Next =
Menu Incr PrSet List
```

Line 1 displays the "heartbeat". The heartbeat is a line that rotates and lets you know that TigerFence is functioning normally. The letter next to the heartbeat is the drive indicator. This tells you what the motor is doing.

Drive Indicator	Meaning
H	Holding Still
A	Accelerating
C	Moving at Constant Speed
D	Decelerating
W	Waiting
S	Stopping
T	Waiting for Text Entry
X	E-stop Error
N	Communication Error

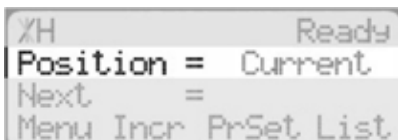

```
XH Ready
Position = Current
Next =
Menu Incr PrSet List
```

Line 2 shows the current position of TigerFence. The position will show with 'in' when in inches mode and 'mm' when in metric mode.

```
%H Ready
Position = Current
Next =
Menu Incr PrSet List
```

Line 3 shows the next position of TigerFence. This is where user input is shown.

```
%H Ready
Position = Current
Next =
Menu Incr PrSet List
```

Line 4 displays the soft key prompts. These prompts tell you what the soft key button below it does. These can change when you access different screens.

## Find the End Limits

The Find end limits routine will make TigerFence physically move between the two end sensors and will automatically set the minimum and maximum limits.

```
%H Ready
Position = Current
Next =
Calib Show
```

1. From the Ready Screen, press the [Show] soft key to show the menu options.

```
%H Ready
Position = Current
Next =
Menu Incr PrSet List
```

2. Press the [Menu] soft key to display the Menu Select screen.

```
%H Menu
Password =
```

3. TigerFence requires a password to access all menu options. Enter your TigerFence password and press .

*Note: By default, the TigerFence password is set to the serial number.*

```
%H ← Select → Menu
A-Setup C-Options
B-Offset D-PartList
A B C D
```

4. At the Menu Select screen, press the [Setup] soft key to access the Setup Menu.

```
%H ←FindLim → Setup
Find the end limits?
Press START to run
```

5. Press  to scroll through the settings. Stop when you see FindLim.

6. Press [Start] to run the Find End Limit routine.

*Note: Ensure TigerFence can move its entire length without obstruction. TigerFence*

*will move once  is pressed.*

When TigerFence has stopped moving, continue to the next set of instructions.

## Auto Detect

```
%H ← Detect → Setup
Auto-detect your
Tool Interconnect?
Press OK to begin.
```

1. Press  to scroll through the settings until you get to the Auto detect setting.



2. Follow the prompts on screen to detect your Interconnect Kit.

## Calibrate TigerStop

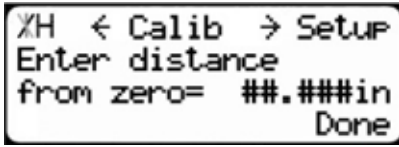

1. Press  to scroll through the settings until you get to the Calib setting.

2. Measure how far the TigerStop is from your tool's zero point.

3. Enter this measurement and press the [Done] soft key.

**Note:** TigerFence has been calibrated and you will be taken back to the Ready Screen.

## Set Kerf

If the tool you have installed TigerStop to is a cutting tool, you will need to set the Kerf setting. The kerf is the measure of how much material is destroyed by the saw blade during a cut.

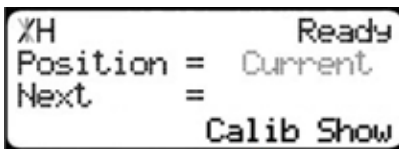

1. From the Ready Screen, press the [Show] soft key to show the menu options.

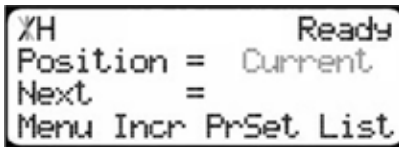

2. Press the [Menu] soft key to display the Menu Select screen.

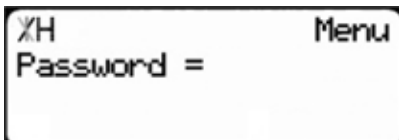

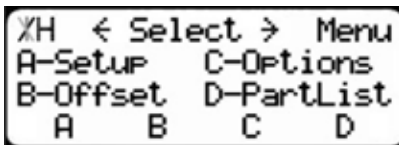

3. TigerFence requires a password to access all menu options. Enter your TigerFence password and press .

**Note:** By default, the TigerFence password is set to the serial number.

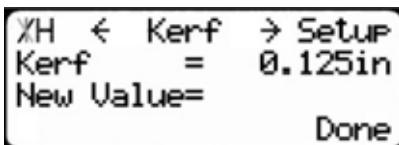

4. At the Menu Select screen, press the [Setup] soft key to access the Setup menu.



5. Press  to scroll through the settings. Stop when you get to the Kerf setting.

To measure kerf...

1. Rip a sample piece and measure it with a caliper. Record your measurement.

2. Rip this piece in half.

3. Put the two pieces together as if they were one piece and re-measure with a caliper.

4. The difference between the measurement on step 1 and the measurement on step 3 will be your Kerf value.

5. Enter your Kerf value and press the [Done] soft key to save the parameter.

**Note:** It is important to check and reset the Kerf every time the saw blade is changed.

## Set Units

TigerFence can display its position in inches or metric. If you do not wish to change the units, skip this step.

```
%H Ready
Position = Current
Next =
Calib Show
```

1. From the Ready Screen, press the [Show] soft key to show the menu options.

```
%H Ready
Position = Current
Next =
Menu Incr PrSet List
```

2. Press the [Menu] soft key to display the Menu Select screen.

```
%H Menu
Password =
```

3. TigerFence requires a password to access all menu options. Enter your TigerFence password and press [=].

*Note: By default, the TigerFence password is set to the serial number.*

```
%H < Select > Menu
A-Setup C-Options
B-Offset D-PartList
A B C D
```

4. At the Menu Select screen, press the [Options] soft key to access the Options menu.

```
%H < Units > Optns
Current units of
measure: INCHES
↑ ↓ Done
```

5. Press  to scroll through the settings. Stop when you get to Units.
6. Press [B] to toggle between inches and metric.
7. Press the [Done] soft key when finished.

## Set Optimizer Settings

TigerStops Dynamic Optimizer is tuned from the factory to give the best overall material yield. However, the optimizer can be configured differently if you have different requirements.

```
%H Ready
Position = Current
Next =
Calib Show
```

1. From the Ready Screen, press the [Show] soft key to show the menu options.

```
%H Ready
Position = Current
Next =
Menu Incr PrSet List
```

2. Press the [Menu] soft key to display the Menu Select screen.

```
%H Menu
Password =
```

3. TigerFence requires a password to access all menu options. Enter your TigerFence password and press [=].

*Note: By default, the TigerFence password is set to the serial number.*

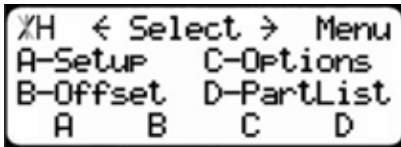

4. At the Menu Select screen, press the [PartList] soft key to access the Part List menu.



5. Press  to scroll through the settings until you get to the Opt Score setting.

The Optimizer Score setting sets the score that the optimizer solution must reach to be considered a good solution.

A lower Opt Score setting will give you a better optimized solution, but will take longer to do so. A higher Opt Score setting will give you a faster solution, but it may give you a lower material yield.

To change Opt Score...

1. Enter the new Opt Score setting.
2. Press  to save the parameter.

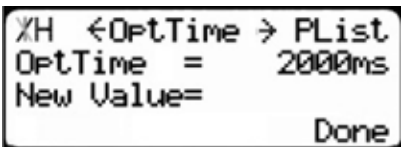

6. Press  to scroll through the settings until you get to the Opt Time setting.

The Optimizer Time setting sets the amount of time the TigerStop Optimizer has to find a solution. If it takes longer than this time, TigerStop will use the best found optimized solution.

A lower Opt Time setting will give you a faster solution, but it may give you a lower material yield. A higher Opt Time setting will give you better material yield, but it may take longer to do so.

To change Opt Time...

1. Enter the new Opt Time setting.
2. Press  to save the parameter.

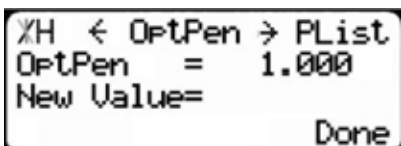

7. Press  to scroll through the settings until you get to the Opt Pen setting.

The Optimizer Penalty setting sets a penalty for multiple board optimized solutions. This means that the higher this setting, the more TigerFence will try to Rip wider parts first.

A lower Opt Pen setting will give you faster optimization with more short parts processed first.

A higher Opt Pen setting will give you a slower optimization with more long parts processed first.

To change Opt Pen...

1. Enter the new Opt Pen setting.
2. Press  to save the parameter.

By adjusting these three optimizer settings, you can greatly influence how the TigerStop optimizer works to suit your exact application.

# Basic TigerFence Functions

## Manual Movement

To manually move TigerFence to a position, you must enter the length you want TigerFence to go to. This length can be entered as a decimal or a fractional value.

### Entering Decimals

```
XH          Ready
Position =   Current
Next       =
          Calib Show
```

1. Start at the Ready Screen.

```
XH          Ready
Position =   Current
Next       = 24.5
          Calib Show
```

2. Enter a length at the controller.

Example: To enter 24 1/2 as a decimal, enter [2] [4] [.] [5].

3. Press [Start] to move TigerFence.

### Entering Fractions

```
XH          Ready
Position =   Current
Next       =
          Calib Show
```

4. Start at the Ready Screen.

```
XH          Ready
Position =   Current
Next       = 24 1/2
          Calib Show
```

5. Enter a length at the controller.

Example: To enter 24 1/2 as a decimal, enter [2] [4]  [1] [/] [2].

```
XH          Ready
Position =   Current
Next       = 24.5
          Calib Show
```

**START**

6. Then press **START** to move TigerFence.

Notice that even though you entered a fraction, TigerFence will display the position as a decimal once it has moved. TigerFence cannot display fractions in the 'Position' field.

### Calculator Mode

TigerFence has a calculator function that can be used to do simple math problems.

```
XH          Ready
Position =   Current
Next       =
          Calib Show
```

1. Start at the Ready Screen.

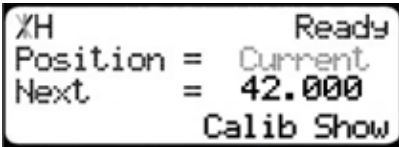

Just like a normal calculator, you can use the math function keys to enter math problems.

Example: I want to add 12 inches to 30 inches.

Press [1] [2] [+] [3] [0] [=].

The answer will appear in the 'Next' field.

**START**

2. Press **START** and TigerFence will move to the calculated position.

You can also do math functions on the current position.

Example: I want to subtract 1.5 inches from my current position of 42 inches.

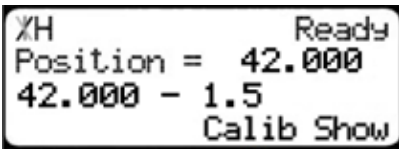

1. Press [-] [1] [.] [5] [=].

The answer will appear in the 'Next' field.

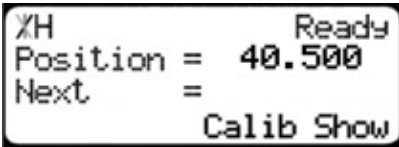



2. Press **START** and TigerFence will move.

## Jog

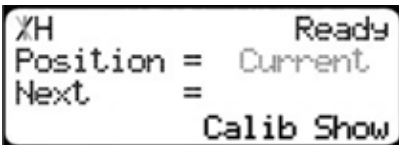
TigerFence can be manually jogged in or out. When activated, TigerFence will move until you let go of the jog button. It will then glide to a gentle stop.



1. Start at the Ready Screen.

2. At the top of the TigerFence controller, you have a  and a . To jog, press and hold one of these buttons.

*Note: If the jog buttons move TigerFence in the wrong direction, you can use the 'Jog Reverse' setting in the 'Setup' menu to reverse the movement.*

## Increment

The increment function is a push feed mode used to step TigerFence through a series of movements. Increment...

- Can be a positive value that will move TigerFence towards the tool.
- Can be a negative value that will move TigerFence away from the tool.
- Will compensate for kerf automatically using the 'Kerf' setting in the 'Setup' menu.
- Can only store one increment value at a time.

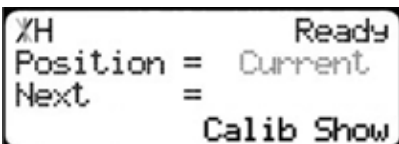

1. Start at the Ready Screen.

2. Press the [Show] soft key to display more options.

```

XH              Ready
Position = Current
Next          =
Menu Incr PrSet List

```

3. A new set of options have appeared. Press the [Incr] soft key to access the Increment menu.

```

TH      Enter   Incr
Position = 42.000
Incr Size=

```

4. Enter the size you want to increment and press . For this example, I am going to use an increment of 2 inches.

```

\H      Incr Move Incr
Position = 42.000in
Next      = 38.875in
Incr Size= 2.000in

```

5. The current position is 42. If that is where you want to start, press  to begin incrementing.

```

XH              Ready
Position = Current
Next          =
Menu Incr PrSet List

```

6. When you are finished, press  to return to the Ready Screen.

## PreSet

The PreSet function is a set of 100 programmable hot keys used to quickly access common lengths. PreSets...

- Can be used in Set Point, Pusher or Increment mode.
- Can be programmed in PreSet slots number 1 - 100.

*Note: PreSet functionality can be changed using the 'PreSet' setting in the Part List menu.*

## PreSet Programming

```

XH              Ready
Position = Current
Next          =
Calib Show

```

1. From the Ready Screen, press the [Show] soft key to show the menu options.

```

XH              Ready
Position = Current
Next          =
Menu Incr PrSet List

```

2. A new set of soft key options have appeared. Press the [PrSet] soft key to access the PreSet feature.

```

TH      Enter   PrSet
Pre-Set#
Press START to move.
View Edit Clear

```

3. Enter the number of the preset you want to program and press the [Edit] soft key.

4. For this example, I am going to program PreSet number 1.

```

TH      <Edit 1> PrSet
Pre-Set = Empty
New Value=15 15/16
View Clear

```

5. Enter the length you want the PreSet to move TigerFence to and press .

For this example, I want to move to 15 15/16 inches.

```
XH <Edit 1 > PrSet
Pre-Set = 15.937in
New Value=
View Clear
```

- The PreSet value is now set.
- Press  to go back to the Ready Screen.

### Using the PreSet

```
XH Ready
Position = Current
Next =
Menu Incr PrSet List
```

- Start at the Ready Screen.
- Press the [PrSet] soft key to access the PreSet menu.

```
TH Enter PrSet
Pre-Set#
Press START to move.
View Edit Clear
```

- Enter the PreSet number you wish to use and press .

```
XH Ready
Position = 15.937
Next =
Menu Incr PrSet List
```

- TigerFence will move to the PreSet position.

### Deleting PreSets

```
XH Ready
Position = Current
Next =
Menu Incr PrSet List
```

- Start at the Ready Screen.
- Press the [PrSet] soft key to access the PreSet menu.

```
TH Enter PrSet
Pre-Set#
Press START to move.
View Edit Clear
```

- Enter the PreSet number you wish to delete and press the [Clear] soft key.

```
XH <Clear 1 > PrSet
Pre-Set = 15.937in
Press OK to clear.
View Edit
```

- Press  to clear.
- TigerFence has now deleted the PreSet.

### Quick Calibration

Quick calibration is a shortcut to the calibration setting. This allows advanced TigerFence users to quickly calibrate.

```
XH Ready
Position = Current
Next =
Calib Show
```

- Start at the Ready Screen.  
*Note: if you viewing the expanded options, press .*

```
XH Calib Ready
Enter distance
from zero=
Done
```

- Measure how far the fence is from your saw blade. Enter this measurement and press the [Done] soft key.
- TigerFence is now calibrated.

# Working with Part Lists

TigerFence has a versatile part list feature that allows users to enter large lists of parts for use with the TigerStop Dynamic Optimization upgrade. This lets the user run, view, edit, clear and optimize lists of parts, then processes the parts quickly and accurately.

There are 4 types of lists that you can enter;

## Pusher

A pusher list will tell TigerFence to push the stock material into the saw. Pusher lists can be optimized if you have the TigerStop Dynamic Optimizing upgrade.

## Set Point

A set point list will tell TigerFence to act as a stop. It will treat each length you enter as an absolute value from your zero point. Set point lists can be optimized if you have the TigerStop Dynamic Optimizing upgrade.

## Pattern

A pattern list will tell TigerFence to process one stock lengths worth of parts in a push feed fashion. It will run the same pattern of parts over and over until its told to stop. Pattern lists cannot be optimized.

## Pull

A pull list works just like a pattern except it pulls away from the zero point instead of pushing towards it. Pull lists cannot be optimized.

## Programming a List

```
%H Ready
Position = Current
Next =
Calib Show
```

1. From the Ready Screen, press the [Show] soft key to show the menu options.

```
%H Ready
Position = Current
Next =
Menu Incr PrSet List
```

2. A new set of soft key options have appeared. Press the [List] soft key to access the List interface.

```
TH Enter List
Partlist#=
Press START to run
View Edit Clear DnLd
```

3. At the List interface, enter the list number you wish to program and press the [Edit] soft key.

*Note: The list number is a memory slot that houses the list. You can choose numbers 1 - 100.*

```
%H SelectType #1
A-Pusher C-Pattern
B-Setpoint D-Pull
A B C D
```

4. Select the type of list you would like to program.



```
%H Select Opt #1
Optimize Part List?
A-Yes C-No
A C
```

5. TigerFence will ask you if you want to optimize the list for material yield. If you choose no, TigerFence will process the list exactly as entered and will NOT optimize for material yield.

```
%H Chnase H&T #1
H&T Cuts = Global
A-Cont. C-Chnase
A C
```

6. Select if you want to use a global or a local head and tail cut.  
*Note: Head and tail cuts are trim cuts at the ends of your material.*

**Global** - Uses the head and tail cut setting from the Part List menu

**Local** - Allows you to set a head and tail cut that is used for this list only.

```
%H Line 1> #1
Lensth = 0.000in
Quantity= 0
Done
```

7. You will now be taken to the programming screen for line 1. Enter the length of the part you wish to process and press . In this example, I will tell TigerFence I want to cut a 24 inch part.

```
%H Line 1> #1
Lensth = 24.000in
Quantity=5
Done
```

8. The cursor will now drop to the quantity. Enter how many parts you want, followed by .

In this example, I will tell TigerFence that I want 5 parts.

```
%H <Line 2> #1
Lensth = 0.000in
Quantity= 0
Done
```

9. You will now be taken to line 2. Repeat steps 7 and 8 until you have entered all the parts you want to precess.

*Note: You can also download all the parts straight from your design file. Downloading is a faster way of importing parts for use with the TigerStop Optimizer.*

10. Press the [Done] soft key when all parts are entered.

```
%H Complete #1
Part List saved!
Press START to run
Press CANCEL to exit
```

11. The list has now been saved.

12. Press  to run the list.



# Maintenance Schedule

Record the following settings for future reference.

Serial Number:	Drive Test Results
Min Limit:	MxP =
Max Limit:	MxN =
Scale:	P+ =
Kerf:	P- =
Lash:	

## Daily

1. Clean all dirt and debris from drive areas.
2. Check all cables for damage.
3. Check calibration, if necessary.

## Quarterly (Every 3 Months)

1. Run a drive test to check machine drive. The Drv, MxP and MxN measurements must be below 12000.

Note: The drive test is inside the Debug menu.

## Yearly

1. Inspect the condition of the drive belt and replace if necessary.
2. Tighten belt.

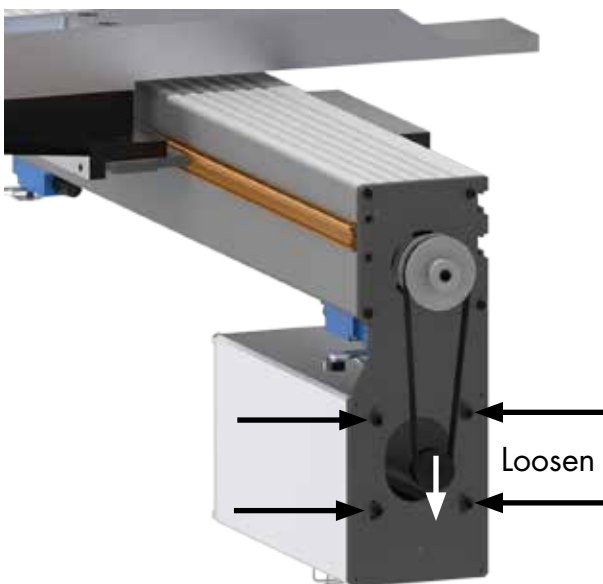

1. Remove the black plastic motor cover.
2. Loosen the four motor mount bolts.
3. Pull down on the motor to tighten the belt.
4. Tighten the motor mount bolts.
5. Replace the motor cover.









FIND US ONLINE AT  
[www.tigerstop.com](http://www.tigerstop.com)

**TigerStop®**  
fast and accurate...every time

12909 NE 95th Street  
Vancouver, WA 98682-2426  
1.360.254.0661  
sales@tigerstop.com

---

**TigerStop B.V. Holland**

31 546 575 171  
info@tigerstop.nl