

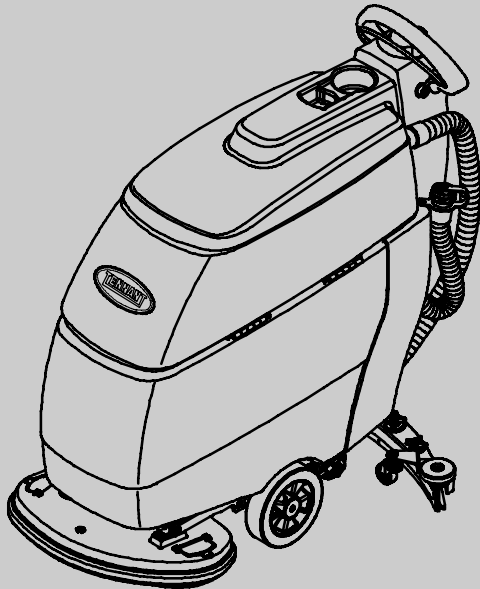

T3/T3+

Scrubber-Dryer

English **EN**
Operator Manual



(S/N T3xxx12000 -)



FaST
Foam Scrubbing Technology

ecH2O™
ELECTRICALLY CONVERTED WATER



www.tennantco.com

9004144
Rev. 03 (04-2010)



This manual is furnished with each new model. It provides necessary operation and maintenance instructions.

Read this manual completely and understand the machine before operating or servicing it.

This machine will provide excellent service. However, the best results will be obtained at minimum costs if:

- The machine is operated with reasonable care.
- The machine is maintained regularly - per the machine maintenance instructions provided.
- The machine is maintained with manufacturer supplied or equivalent parts.

Parts and supplies may be ordered online, by phone, by fax or by mail.

MACHINE DATA

Please fill out at time of installation for future reference.

Model No. - _____

Serial No. - _____

Machine Options - _____

Sales Rep. - _____

Sales Rep. phone no. - _____

Customer Number - _____

Installation Date - _____

PROTECT THE ENVIRONMENT



Please dispose of packaging materials, old machine components such as batteries, hazardous fluids such as anti-freeze and oil, in a safe environmentally way according to your local waste disposal regulations.



Always remember to recycle.

TENNANT N.V.
Industrielaan 6 5405 AB
P.O. Box 6 5400 AA Uden-The Netherlands
 europe@tenantco.com www.tenantco.com

Specifications and parts are subject to change without notice.
 Original instructions, copyright ©2008, 2010 Tennant Company. All rights reserved.

EN **EC DECLARATION OF CONFORMITY FOR MACHINERY** (Annex II, sub A)

TENNANT N.V.
 Industrielaan 6 5405 AB
 P.O. Box 6 5400 AA
 Uden-The Netherlands
 Uden/Netherlands, 25-1-2010

Models: **T3 / T3+** nr.: MT3

Herewith declares, on our own responsibility, that the machinery

- is in conformity with the provisions of the Machinery Directive (2006/42/EC), as amended with national implementing legislation
- is in conformity with the provisions of the E.M.C. Directive 2004/108/EC

and that

- the following (parts/clauses of) harmonized standards have been applied: EN ISO 14121-1, EN 1037, EN 60335-1, EN 60204-1, EN ISO 13849-1, EN ISO 13849-2, EN 60529, EN ISO 4413, EN 349, EN 55012, EN 61000-6-2, EN ISO 11201, EN ISO 4871, EN ISO 3744*, EN ISO 13059*, EN ISO 3450, EN 60335-2-72.
- the following (parts/clauses of) national technical standards and specifications have been used: NA

Richard van den Hoogen
 Richard van den Hoogen
 Safety, Compliance, Documentation & Certification

CE

TABLE OF CONTENTS

SAFETY PRECAUTIONS	4	MACHINE MAINTENANCE	18
SAFETY LABELS	5	DAILY MAINTENANCE	18
MACHINE COMPONENTS	6	MONTHLY MAINTENANCE	20
CONTROL PANEL SYMBOLS	7	MOTOR MAINTENANCE	20
MACHINE INSTALLATION	7	FAST SYSTEM MAINTENANCE	20
UNCRATING MACHINE	7	EC-H ₂ O MODULE FLUSH PROCEDURE ..	21
INSTALLING BATTERIES	7	SQUEEGEE BLADE REPLACEMENT	21
HOW THE MACHINE WORKS	8	SQUEEGEE BLADE ADJUSTMENT	22
BRUSH AND PAD INFORMATION	8	BATTERY MAINTENANCE (LEAD ACID BATTERIES)	22
MACHINE SETUP	9	BRUSH MOTOR BELT REPLACEMENT (DUAL DISK MODELS)	23
ATTACHING SQUEEGEE ASSEMBLY	9	TRANSPORTING MACHINE	24
INSTALLING BRUSHES/PADS	9	STORING MACHINE	24
INSTALLING FAST-PAK (FAST MODEL) ..	10	FREEZE PROTECTION	24
FILLING SOLUTION TANK	10	RECOMMENDED STOCK ITEMS	25
MACHINE OPERATION	11	TROUBLESHOOTING	26
PRE-OPERATION CHECKS	11	BATTERY METER LED FAULT CODES (DRIVE MODEL)	28
OPERATING THE MACHINE	11	SPECIFICATIONS	29
EMERGENCY STOPPING (DRIVE MODEL)	13	MACHINE DIMENSIONS	30
WHILE OPERATING MACHINE	13		
BATTERY METER	14		
CIRCUIT BREAKER	14		
HOUR METER	14		
DRAINING TANKS	15		
DRAINING RECOVERY TANK	15		
DRAINING SOLUTION TANK	15		
CHARGING BATTERIES	16		
BATTERY CHARGER SPECIFICATIONS: ..	16		
USING THE ON-BOARD			
BATTERY CHARGER	16		
ON-BOARD BATTERY CHARGER			
FAULT CODES	17		

SAFETY PRECAUTIONS

This machine is intended for commercial use. It is designed exclusively to scrub hard floors in an indoor environment and is not constructed for any other use. Only use recommended pads, brushes and commercially approved floor cleaners intended for machine application.

The following warning alert symbol and the "FOR SAFETY" heading are used throughout this manual as indicated in their description:

 **WARNING:** To warn of hazards or unsafe practices which could result in severe personal injury or death.

FOR SAFETY: To identify actions which must be followed for safe operation of equipment.

The following safety precautions signal potentially dangerous conditions to the operator or equipment. All operators must read, understand and practice them.

 **WARNING: Fire Or Explosion Hazard:**

- Never Use Flammable Liquids Or Operate Machine in Or Near Flammable Liquids, Vapors Or Combustible Dusts.

This machine is not equipped with explosion proof motors. The electric motors will spark upon start up and during operation which could cause a flash fire or explosion if machine is used in an area where flammable vapors/liquids or combustible dusts are present.

- Do Not Pick Up Flammable Materials Or Reactive Metals.
- Batteries Emit Hydrogen Gas. Keep Sparks And Open Flame Away. Keep Battery Compartment Open When Charging.

 **WARNING: Electrical Hazard**

- Disconnect Battery Cables and Charger Plug Before Servicing Machine.
- Do Not Charge Batteries with Damaged Power Supply Cord. Do Not Modify Plug.

If the charger supply cord is damaged or broken, it must be replaced by the manufacturer or its service agent or a similarly qualified person in order to avoid a hazard.

 **WARNING: Spinning Brush. Keep Hands Away. Turn Off Power Before Working On Machine.**

FOR SAFETY:

1. Do not operate machine:
 - With flammable liquids or near flammable vapors as an explosion or flash fire may occur.
 - Unless trained and authorized.
 - Unless operator manual is read and understood.
 - If not in proper operating condition.
2. Before starting machine:
 - Make sure all safety devices are in place and operate properly.
3. When using machine:
 - Go slow on inclines and slippery surfaces.
 - Wear non-slip shoes.
 - Reduce speed when turning.
 - Report machine damage or faulty operation immediately.
 - Never allow children to play on or around.
 - Follow mixing and handling instructions on chemical containers.
 - Do not operate on inclines that exceed 5% (3°).
4. Before leaving or servicing machine:
 - Stop on level surface.
 - Turn off machine.
 - Set parking brake.
 - Remove key.
5. When servicing machine:
 - Avoid moving parts. Do not wear loose jackets, shirts, or sleeves.
 - Disconnect battery connections before working on machine.
 - Wear protective gloves and eye protection when handling batteries or battery cables.
 - Avoid contact with battery acid.
 - Wear protective gloves and eye protection when handling white vinegar.
 - Do not power spray or hose off machine. Electrical malfunction may occur.
 - Use manufacturer supplied or approved replacement parts.
 - All repairs must be performed by a qualified service person.
 - Do not modify the machine from its original design.

6. When transporting machine:

- Turn machine off.
- Do not lift machine when batteries are installed.
- Get assistance when lifting machine.
- Use a recommended ramp when loading/unloading into/off truck or trailer.
- Use tie-down straps to secure machine to truck or trailer.
- Put scrub head in the lowered position.
- Set parking brake.

SAFETY LABELS

The safety labels appear on the machine in the locations indicated. Replace labels if they are missing or become damaged or illegible.



BATTERY CHARGE LABEL - Located near battery compartment

⚠ WARNING: Fire Or Explosion Hazard. Batteries Emit Hydrogen Gas. Keep Sparks And Open Flame Away. Keep Battery Compartment Open When Charging.



SPINNING BRUSH LABEL - Located on scrub head





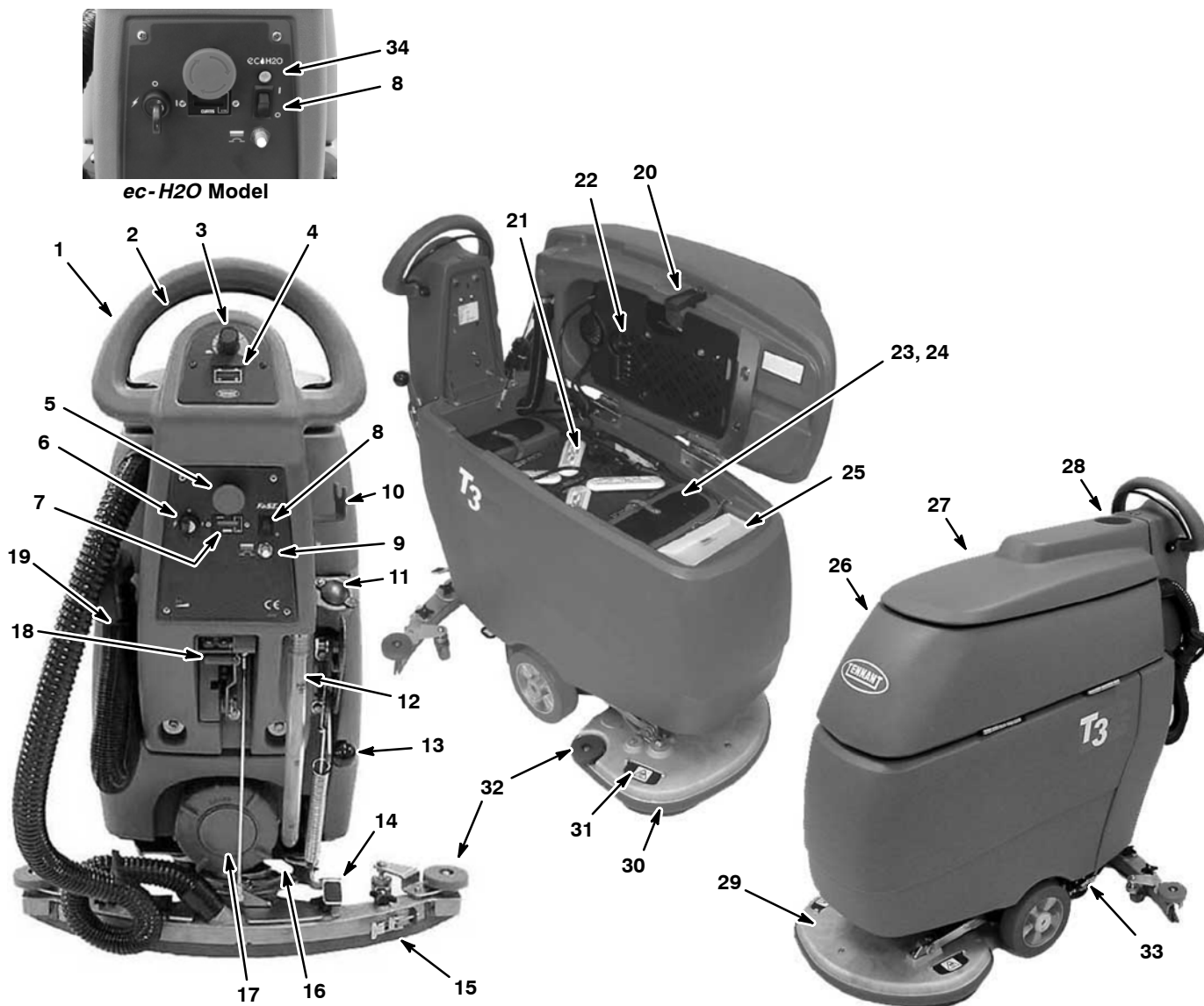





⚠ WARNING: Spinning Brush. Keep Hands Away. Turn Off Power Before Working On Machine.

MACHINE COMPONENTS



- | | |
|---|--|
| <ol style="list-style-type: none"> 1. Control Handle 2. Control Handle Start Bail 3. Speed Control Knob (drive model) 4. Battery Meter 5. Emergency Stop Button (drive model) 6. Main Power Key Switch 7. Hour Meter 8. FaST System On/Off Switch (FaST Model)
<i>ec-H2O system on/off switch (ec-H2O Model)</i> 9. Brush Motor Circuit Breaker Button 10. Squeegee Storage Bracket 11. Hose Fill-Port 12. Solution Tank Level/Drain Hose 13. Heavy Down Pressure Lever (60 cm model) 14. Scrub Head Lift Pedal 15. Squeegee Assembly 16. Solution Flow Control Knob 17. Solution Tank Clean-Out Port 18. Squeegee Lift Lever | <ol style="list-style-type: none"> 19. Recovery Tank Drain Hose 20. Recovery Tank Support Stand 21. Batteries 22. On-board Battery Charger 23. Solution Tank 24. Bucket Fill Port/Clean-out Port 25. FaST-PAK Concentrate (FaST Model)
<i>ec-H2O System Module (ec-H2O Model)</i> 26. Recovery Tank 27. Recovery Tank Cover 28. Cup Holder 29. Scrub Head 30. Pad/Brush 31. Pad Driver Window 32. Wall Rollers 33. Parking Brake 34. <i>ec-H2O System Indicator light (ec-H2O Model)</i> |
|---|--|

CONTROL PANEL SYMBOLS

	Main Power I/O Key Switch		FaST System I/O Switch (FaST Model)		5% (3°) Maximum Machine Climb
	Slow Speed		ec-H2O System I/O Switch (ec-H2O Model)		Solution Flow Control
	Fast Speed		Brush Motor Circuit Breaker		Parking Brake
			Bail Direction		Heavy scrub brush down pressure (60 cm Model)

MACHINE INSTALLATION

UNCRATING MACHINE

- Carefully check the shipping crate for signs of damage. Report damages at once to carrier.
- Check the contents list. Contact distributor for missing items.

Contents:

- 2-12 V Batteries-Optional
- 2-Foam Battery Spacers (#630375)
- Battery Tray (#1012994)
- 38 cm Battery Cable (#1011749)
- 1-FaST-PAK 365 Concentrate (#999005) (FaST Model)
- Squeegee Assembly

Pad drivers, brushes and pads must be purchased separately.

- To uncrate your machine, remove the shipping hardware and straps that secure the machine to the pallet. With assistance, carefully lift the machine off the pallet.

ATTENTION: Do not roll machine off pallet unless a ramp is used, machine damage may occur.

ATTENTION: To prevent possible machine damage, install batteries after removing machine from shipping pallet.

INSTALLING BATTERIES

⚠ WARNING: Fire Or Explosion Hazard. Batteries Emit Hydrogen Gas. Keep Sparks And Open Flame Away. Keep Battery Hood Open When Charging.

FOR SAFETY: When servicing machine, wear protective gloves and eye protection when handling batteries and battery cables. Avoid contact with battery acid.

Battery Specifications:

Two 12 volt, 100A/5h, 105A/5h or 110A/5h deep cycle batteries. Maximum battery dimensions: 174 mm W x 380 mm L x 284 mm H.

- Park the machine on a level surface, remove the key and set parking brake.
- Lift the recovery tank to access the battery compartment. Remove the loose battery cable from the compartment (Figure 1).



FIG. 1

- Carefully install the batteries into the battery compartment tray and arrange the battery posts as shown (Figure 2). Insert the two foam spacers in front of the batteries as shown.

ATTENTION: Do not drop the batteries into the compartment, battery and machine housing damage may result.

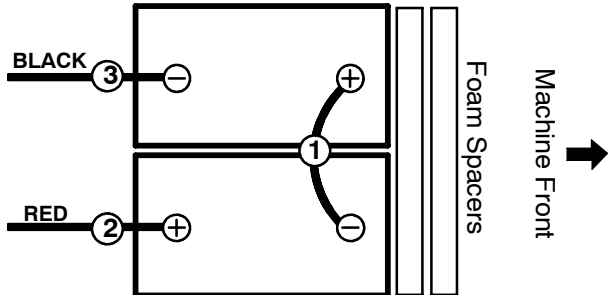

FIG. 2

- Connect the cables to the battery posts in numerical order as labeled (Figure 2), RED TO POSITIVE (+) & BLACK TO NEGATIVE (-).

IMPORTANT: Before charging batteries, make sure the on-board battery charger is properly set for your battery type (See USING THE ON-BOARD CHARGER).

HOW THE MACHINE WORKS

Conventional Scrubbing (Standard Model):

Water and detergent from the solution tank flow to the floor through a manually controlled solution valve. The brush uses the detergent and water solution to scrub the floor clean. As the machine moves forward, the squeegee wipes the dirty solution from the floor into the recovery tank.

Foam Scrubbing (FaST Model):

(FaST-Foam Scrubbing Technology)

Unlike conventional scrubbing, the FaST system injects the patented FaST-PAK concentrate formula with a small amount of water and air onto the floor. The mixture creates a large volume of expanded wet foam for the brush to scrub the floor clean. As the machine moves forward, the foam collapses and the squeegee wipes the dirty solution into the the recovery tank leaving the floor completely dry and slip free.

ec-H₂O Scrubbing (ec-H₂O Model):

(ec-H₂O-electrically converted water)

Normal water passes through a module where it is oxygenated and charged with an electric current. The electrically converted water changes into a blended acidic and alkaline solution forming a neutral pH cleaner. The converted water attacks the dirt, breaks it into smaller particles, and pulls it off the floor surface allowing the machine to easily scrub away the suspended soil. The converted water then returns to normal water in the recovery tank.

BRUSH AND PAD INFORMATION

For best cleaning results use the appropriate brush type for your cleaning application. Refer to the Parts manual for part number information.

Polypropylene Bristle Scrub Brush (Black) -

This general purpose polypropylene bristle scrub brush is used for scrubbing lightly compacted soilage. This brush works well for maintaining concrete, wood and grouted tile floors.

Soft Nylon Bristle Scrub Brush (White) -

Recommended for cleaning coated floors without removing finish. Cleans without scuffing.

Super Abrasive Bristle Scrub Brush (Gray) -

Nylon fiber impregnated with abrasive grit to remove stains and soilage. Strong action on any surface. Performs well on buildup, grease, or tire marks.

Polishing Pad (White) -

Used to maintain highly polished or burnished floors.

Buffing Pad (Red) - Used for light duty scrubbing without removing floor finish.

Scrubbing Pad (Blue) - Used for medium to heavy-duty scrubbing. Removes dirt, spills, and scuffs and leaves surface clean ready for recoating.

Stripping Pad (Brown) - Used for stripping of floor finish to prepare the floor for recoating.

Heavy Duty Stripping Pad (Black) - Used for aggressive stripping of heavy finishes/sealers, or very heavy duty scrubbing.

MACHINE SETUP

ATTACHING SQUEEGEE ASSEMBLY

1. Park the machine on a level surface, remove the key and set the parking brake.
2. Lift the squeegee lift lever to the upward position (Figure 3).

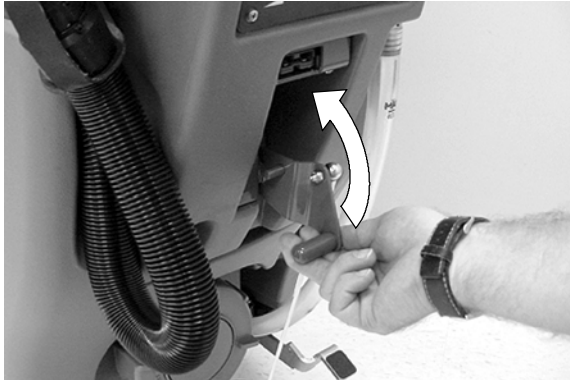

FIG. 3

3. Mount the squeegee assembly to the squeegee pivot bracket as shown (Figure 4). Make sure the knobs are completely seated into the slots before securing knobs.

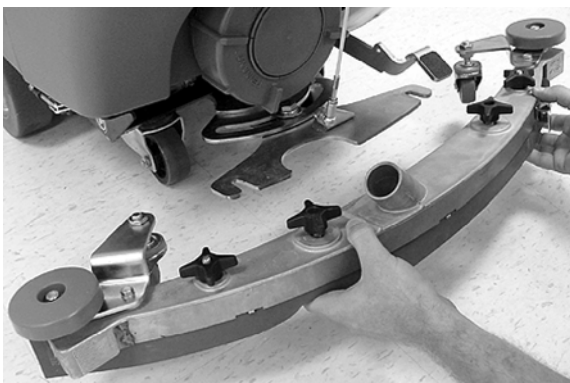

FIG. 4

4. Connect the vacuum hose to the squeegee assembly. Loop the hose as shown using the hose clip provided (Figure 5).

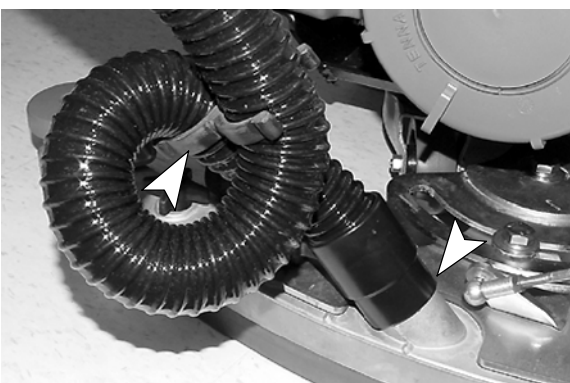

FIG. 5

5. Check the squeegee blades for proper adjustment (See *SQUEEGEE BLADE ADJUSTMENT*).

INSTALLING BRUSHES/PADS

NOTE: Consult your authorized distributor for pad and brush recommendations.

1. Park the machine on a level surface, remove the key and set the parking brake.
2. Step down on the scrub head lift pedal to raise the scrub head off the floor (Figure 6).

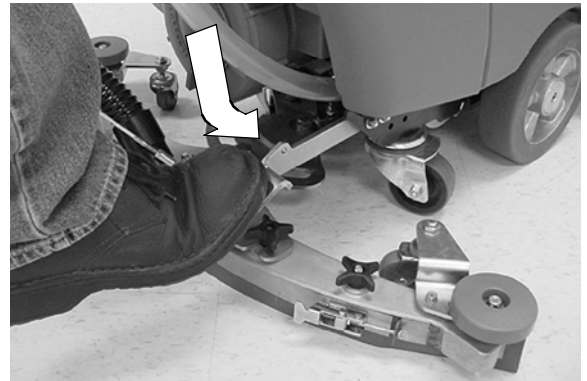

FIG. 6

3. Attach the pad to the pad driver before installing the driver. Make sure the pad is centered on the driver (Figure 7). The 43 cm single disk and 60 cm dual disk models require pad centerlocks to hold pad in place.

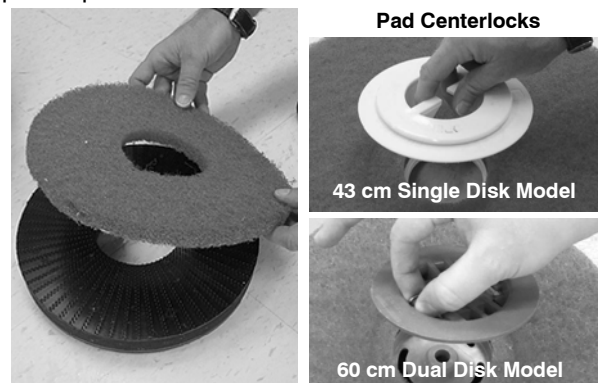

FIG. 7

4. Align the pad driver mounting studs into the motor hub slots and give the pad driver a quick turn to engage spring clip (Figure 8).

NOTE: For the 50 cm and 60 cm dual disk models, the left and right pad drivers engage the spring clip in opposite directions.

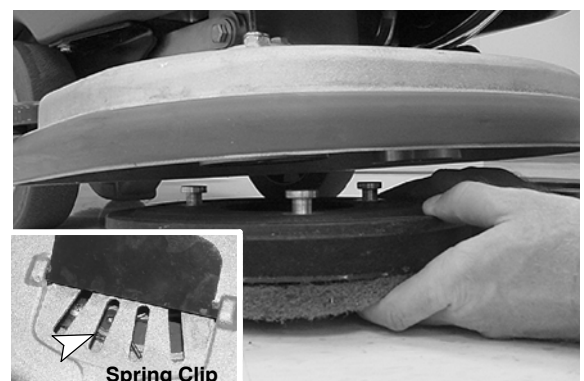

FIG. 8

- To remove the pad driver, grip the driver and give it a quick turn away from the spring clip.

INSTALLING FaST-PAK (FaST Model)

FaST 365 Floor Cleaning Concentrate (#999005)

ATTENTION: The FaST-PAK Concentrate Formula is specifically designed for the FaST system. NEVER use a substitute, machine damage may result.

- Remove the perforated knock-out from the FaST-PAK carton. Do not remove the bag from the carton. Pull the hose connector through the knock-out and remove the orange cap (Figure 9).

FOR SAFETY: When using machine, always follow the handling instructions on chemical container.

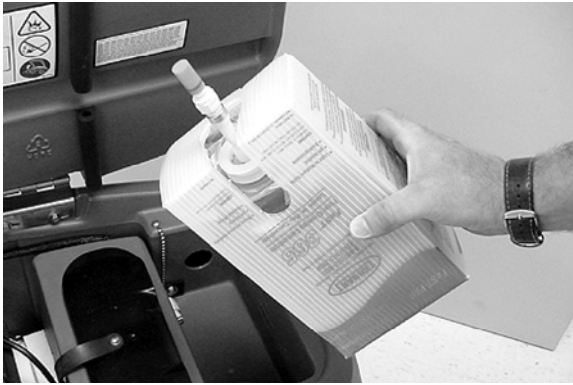

FIG. 9

- Lift the recovery tank to access the FaST-PAK compartment. Connect the supply hose to the FaST-PAK and place the FaST-PAK carton into the compartment as shown (Figure 10). Make sure that the supply hose doesn't get kinked or pinched.

NOTE: If any dried concentrate is visible on the supply hose connector or on the FaST-PAK connector, soak and clean with warm water.



FIG. 10

- When the supply hose is not in use, make sure to connect it to the storage plug (Figure 11). This will prevent the FaST system from drying out and clogging up the supply hose.

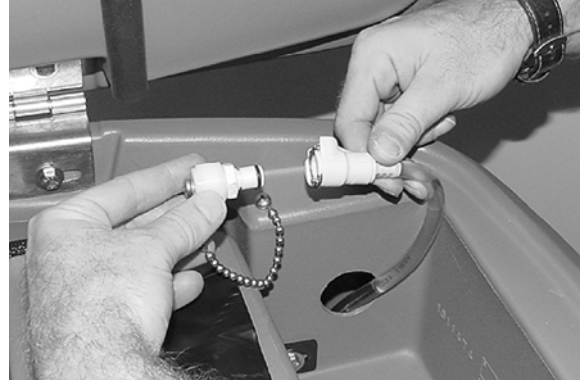

FIG. 11

FILLING SOLUTION TANK

The machine is equipped with a hose fill-port at the rear of the machine, and a bucket fill-port located under the recovery tank (Figure 12). Before accessing the bucket fill-port make sure that the recovery tank is empty.

Fill the solution tank to the "40 L MAX" level mark on the solution tank drain hose. When using the bucket fill-port, stop filling when the level reaches the bottom edge of the fill-port (Figure 12).

FOR FaST or ec-H2O SCRUBBING: Use cool clean water (<21°C). Do not add any conventional floor cleaning detergents, system failure may result.

FOR CONVENTIONAL SCRUBBING: Fill tank with water (60°C maximum). Pour a recommended cleaning detergent into the solution tank according to mixing instructions on the bottle.



FIG. 12

NOTE: When filling the solution tank with a bucket, make sure that the bucket is clean. Do not use the same bucket for filling and draining the machine.

ATTENTION: For Conventional Scrubbing, only use recommended cleaning detergents. Machine damage due to improper detergent usage will void the manufacturer's warranty.

⚠ WARNING: Fire or Explosion Hazard. Never Use Flammable Liquids.

FOR SAFETY: When using machine, follow mixing and handling instructions on chemical containers.

MACHINE OPERATION

FOR SAFETY: Do not operate machine, unless operator manual is read and understood.

⚠ WARNING: Fire Or Explosion Hazard. Never Operate Machine In Or Near Flammable Liquids, Vapors Or Combustible Dusts.

PRE-OPERATION CHECKS

- Sweep and dust-mop the floor.
- Check the battery meter charge level (See BATTERY METER).
- Check the pad(s)/brush(es) for wear.
- Check the squeegee blades for wear and proper adjustment.
- Make sure the recovery tank is empty and the float shut-off screen is installed and clean.
- 43cm Single Disk Model: Check the scrub head skirt for wear.
- For FaST Scrubbing:** Check the FaST-PAK concentrate level.
- For FaST or ec-H2O Scrubbing:** Make sure the solution tank is filled with cool clean water only.
- For FaST or ec-H2O Scrubbing:** Ensure that all conventional cleaning agents are drained and rinsed from solution tank.

OPERATING THE MACHINE

1. Release the parking brake (Figure 13).
2. Turn the main power key switch to the on (I) position (Figure 13).

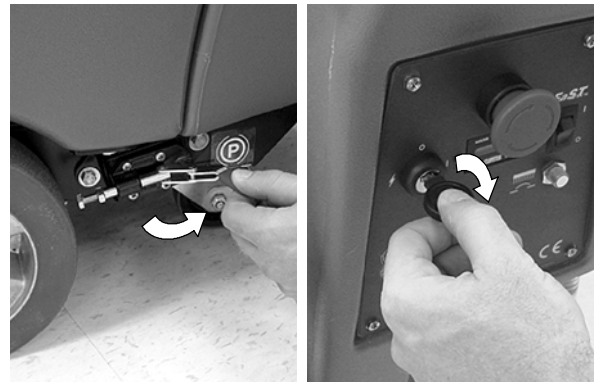

FIG. 13

3. **FaST Model:** To foam scrub, press the FaST system switch to the on (I) position (Figure 14).
- ec-H2O Model:** Press the ec-H2O system switch to the on (I) position (Figure 14).

NOTE: The ec-H2O system indicator light will not turn on until the machine starts scrubbing.

IMPORTANT: NEVER turn the FaST/ec-H2O system switch on when conventional scrubbing. Conventional cleaning detergents/restorers may cause failure to the FaST/ec-H2O solution system. Drain, rinse and refill solution tank with cool clean water before operating the FaST/ec-H2O system.

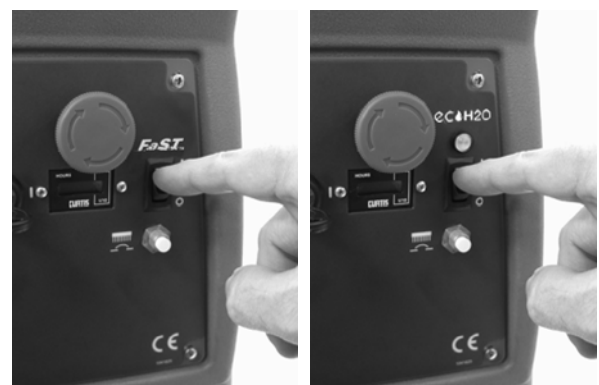

FIG. 14

- Lower the squeegee assembly to floor by lowering the squeegee lift lever (Figure 15). *The vacuum motor will automatically turn on.*

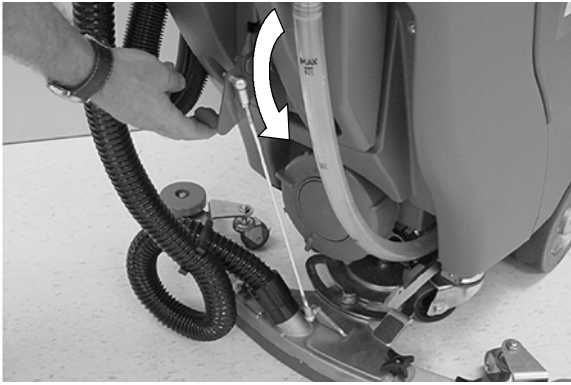

FIG. 15

- Lower the scrub head to the floor by stepping on the scrub head lift pedal as shown (Figure 16).

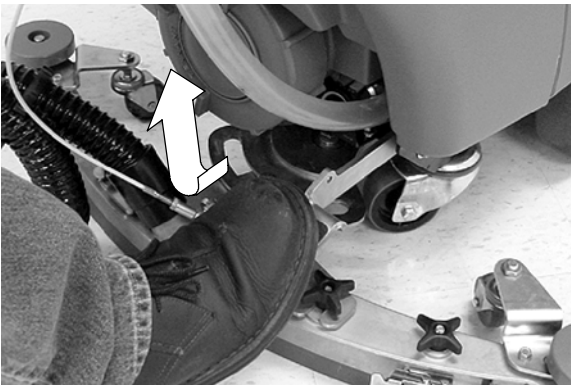

FIG. 16

- Pull the control handle bail backwards to start scrubbing (Figure 17). The drive model will automatically propel forward. To reverse the drive model, simply push the control handle bail forward.

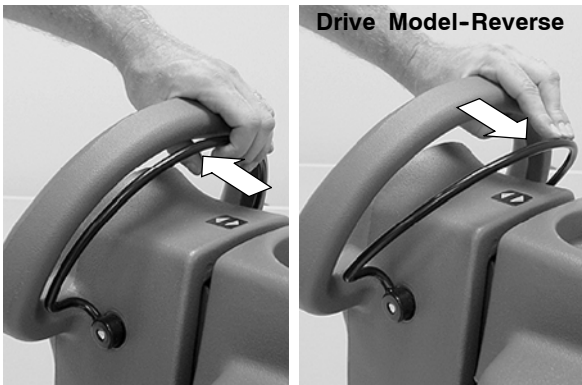

FIG. 17

- Drive Model: Adjust the speed control knob to a desired scrubbing speed (Figure 18).

NOTE: 45–60 meters per minute is the recommended scrubbing speed.



FIG. 18

- For conventional scrubbing, turn the solution flow control knob to a desired flow rate (Figure 19).

NOTE: For the FaST and ec-H2O models, the solution flow rate is fixed and requires no adjustment. The ec-H2O module has optional flow rate settings. If solution flow adjustments are required, contact an Authorized Service Center.

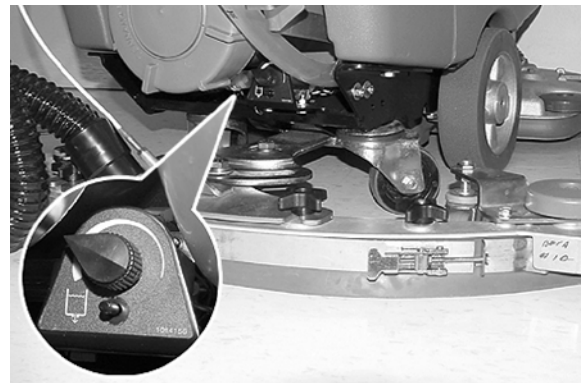

FIG. 19

- When additional brush pressure is needed for heavily soiled areas simply lift the down pressure lever (Figure 20). This feature is only offered on the dual disk 60cm models.



FIG. 20

- To stop scrubbing, release the control handle bail, raise the scrub head and the squeegee.

EMERGENCY STOPPING (Drive Model)

Strike the emergency-stop button, located on the control panel, to stop the machine in an emergency. Turn the button clockwise to reset (Figure 21).

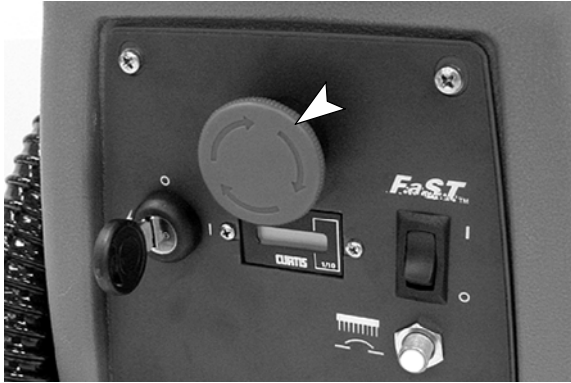

FIG. 21

WHILE OPERATING MACHINE

⚠ WARNING: Fire Or Explosion Hazard. Do Not Pick Up Flammable Materials Or Reactive Metals.

1. Overlap each scrubbing path by 5 cm.
2. Keep the machine moving to prevent damage to floor finish.
3. Wipe the squeegee blades with a cloth if blades leave streaks. Pre-sweep the area to prevent streaking.
4. Do not operate the machine on inclines that exceed 5% (3°).

FOR SAFETY: When using machine, go slow on inclines and slippery surfaces.

5. Conventional scrubbing: Pour a recommended foam control solution into the recovery tank if excessive foam appears.

ATTENTION: Do not allow foam to enter the float shut-off screen, vacuum motor damage will result. Foam will not activate the float shut-off screen.

6. Use the double scrubbing method for heavily soiled areas. First scrub the area with the squeegee up, let solution set for 3-5 minutes, then scrub the area a second time with squeegee down.
7. Change or rotate pads as needed.
8. Observe the battery meter discharge level (See BATTERY METER).
9. Observe the solution tank level hose for remaining solution. 10 liters will last approximately 10 minutes during conventional scrubbing and 20 minutes during foam scrubbing with the FaST Model.
10. When the solution tank runs dry, empty the recovery tank before refilling.

11. When leaving the machine unattended, remove the key and set the parking brake.
12. **ec-H2O Model:** If an alarm sounds and the ec-H2O system indicator light begins to blink red, the ec-H2O module must be flushed to resume ec-H2O operation (See ec-H2O MODULE FLUSH PROCEDURE) (Figure 22).

NOTE: When the alarm sounds and the light blinks red, the machine will bypass the ec-H2O system. To continue scrubbing, turn the ec-H2O switch off and change over to conventional scrubbing.

ATTENTION: (ec-H2O model) Do not allow solution tank to run dry. ec-H2O module failure may result if operated without water for an extended period.



FIG. 22

ec-H2O SYSTEM INDICATOR LIGHT CODE	CONDITION
Solid green	Normal operation
Blinking red	Flush ec-H2O module
Solid red	Contact Service Center

13. When transporting or storing machine, remove the squeegee assembly and hang it on the storage bracket (Figure 23).

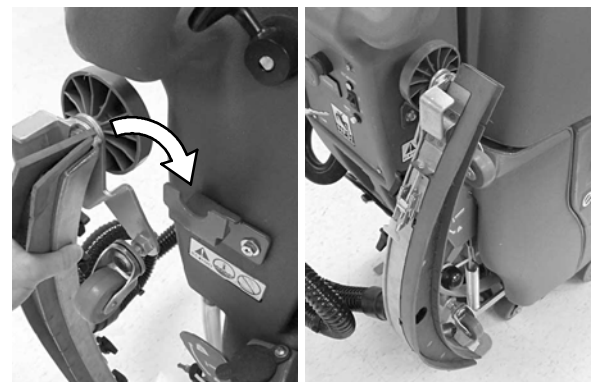

FIG. 23

14. Perform the Daily Maintenance procedures after scrubbing (See MACHINE MAINTENANCE).

BATTERY METER

The battery meter displays the charge level of the batteries. When the batteries are fully charged, all indicator lights are lit. As the batteries discharge, the indicator lights will begin to go out from right to left. To prolong the life of the batteries, do not allow the indicator lights to go beyond the discharge level as described below.

NOTE: ONLY recharge the batteries when the machine is used for a total of 30 minutes or more.

DRIVE MODEL BATTERY METER: When the discharge level reaches the first red light, stop scrubbing and recharge the batteries (Figure 24). If the last red light begins to flash, the scrubbing function will shut off automatically. This protects the batteries from total discharge. Drive the machine to the charging area and recharge the batteries immediately.

NOTE: The Drive Model battery meter also displays machine fault codes. If a fault is detected the LED bars will flash specific fault codes (See BATTERY METER LED FAULT CODES).



FIG. 24

PUSH MODEL BATTERY METER: When the discharge level reaches the last yellow light, the light will begin to flash, stop scrubbing and recharge the batteries (Figure 25). If the red light appears, the scrubbing function will shut off automatically. This protects the batteries from total discharge. Recharge the batteries immediately.

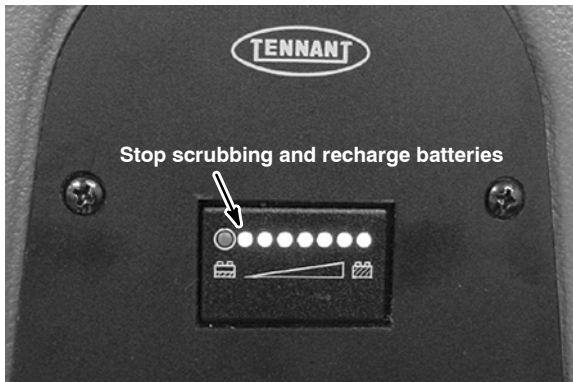

FIG. 25

CIRCUIT BREAKER

The machine is equipped with a resettable circuit breaker to protect the brush motor from damage. The circuit breaker button is located on the control panel (Figure 26). If the circuit breaker should trip, determine the cause, allow the motor to cool, and then manually reset the circuit breaker button.

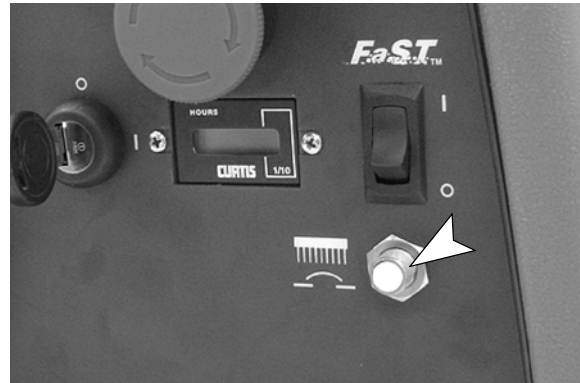

FIG. 26

HOURLY METER

The hour meter records the number of total hours the brush motor has been powered on. Use the hour meter to determine when to perform recommended maintenance procedures and to record service history (Figure 27).

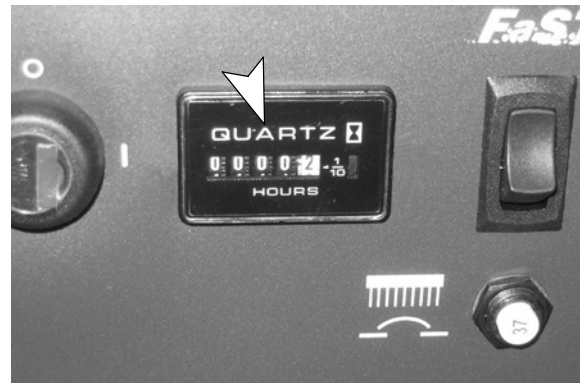

FIG. 27

DRAINING TANKS

The recovery tank should be drained and cleaned out after every use. The solution tank should be cleaned out periodically to remove any corrosion.

Transport the machine to a draining site, turn the key off and follow the draining instructions below:

FOR SAFETY: Before leaving or servicing machine, stop on level surface, turn off machine and remove key.

DRAINING RECOVERY TANK

1. While holding the drain hose upward, remove the cap and lower hose to drain (Figure 28).

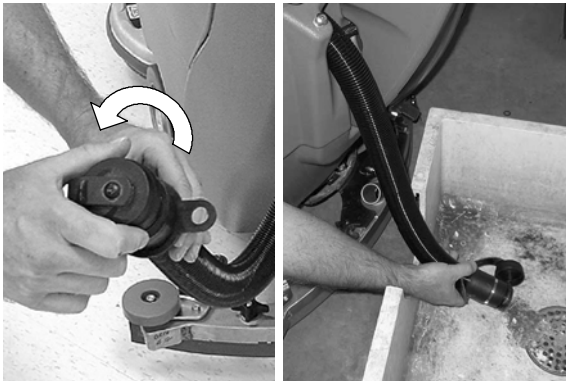

FIG. 28

NOTE: When using a bucket to drain the machine, do not use the same bucket to fill the solution tank.

2. Open the recovery tank cover and rinse out the tank. Use a rag to remove any excess dirt (Figure 29).



FIG. 29

3. Clean the float shut-off screen and debris tray located in the recovery tank (Figure 30).

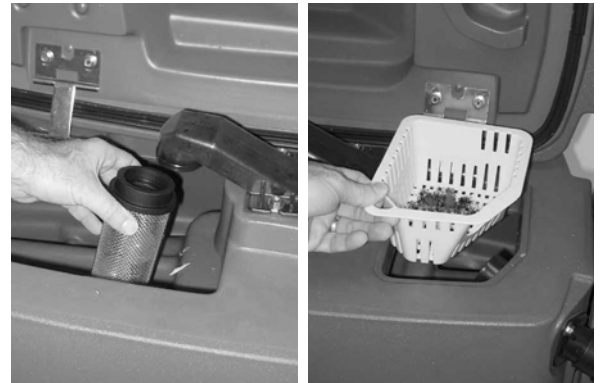

FIG. 30

DRAINING SOLUTION TANK

1. To drain any remaining water from the solution tank, pull the solution tank level hose off the hose fitting as shown (Figure 31).

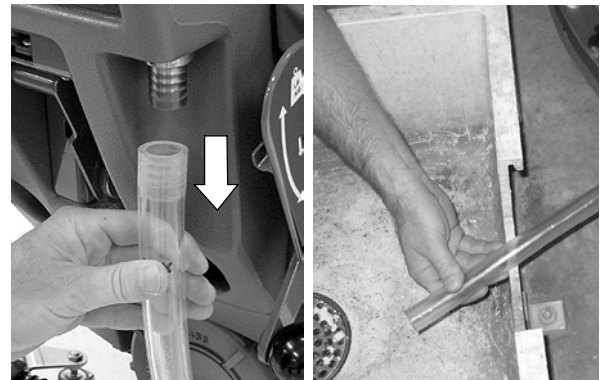

FIG. 31

2. To rinse out the solution tank, remove the clean-out cap at the rear of the machine and spray water (60°C maximum) directly into the two fill-ports located under the recovery tank (Figure 32).

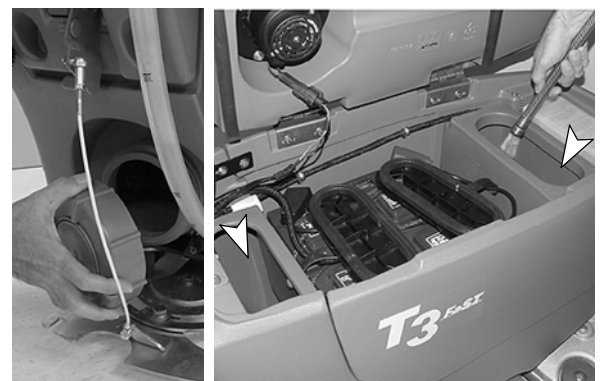

FIG. 32

- Remove and clean the solution tank filter (Figure 33). Turn the filter counter-clockwise to remove.



FIG. 33

- After rinsing out the tank, securely replace the solution tank filter, clean-out cap, fill-port covers and hose.

During charger start-up, if the red light flashes twice, the charger is set for wet/lead acid batteries. If the green light flashes twice, the charger is set for an AGM/Gel/ sealed/maintenance free batteries (Figure 34).

NOTE: If using a low maintenance (LM) lead-acid battery or an Exide gel battery, refer to the Charger Profile Switch Configuration (Figure 37).



FIG. 34

CHARGING BATTERIES

ATTENTION: To prolong the life of the batteries only recharge the batteries if the machine was used for a total of 30 minutes or more. Do not leave batteries discharged for lengthy periods.

⚠ WARNING: Fire Or Explosion Hazard. Batteries Emit Hydrogen Gas. Keep Sparks And Open Flame Away. Keep Battery Compartment Open When Charging.

FOR SAFETY: When servicing batteries, wear protective gloves and eye protection when handling batteries and battery cables. Avoid contact with battery acid.

To change the charger profile:

- Remove the knob that holds the battery charger mounting panel in position and remove panel to access battery charger (Figure 35).



FIG. 35

- Peel back the corner of the display label on the charger to access the profile switches (Fig. 36).

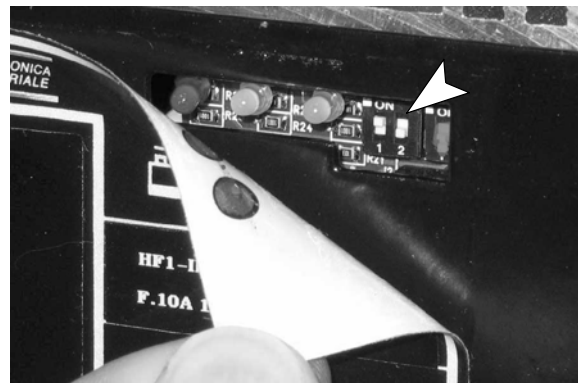

FIG. 36

BATTERY CHARGER SPECIFICATIONS:

- CHARGER TYPE:
 - FOR SEALED (Gel) BATTERIES
 - FOR WET (Lead acid) BATTERIES
- OUTPUT VOLTAGE - 24 VOLTS
- OUTPUT CURRENT - 13 AMPS
- AUTOMATIC SHUTOFF CIRCUIT
- FOR DEEP CYCLE BATTERY CHARGING

USING THE ON-BOARD BATTERY CHARGER

IMPORTANT: Before charging batteries, make sure the charger profile is properly set for your battery type (ex. lead-acid, gel, etc.). Failure to properly set charger may result in battery damage.

To determine your battery type, see battery label. If not specified, contact your battery supplier.

To verify the setting of the charger profile:

- Set the profile switches according to the switch configuration table (Fig. 37). The charger cord must be unplugged when resetting.

Charger Profile Switch Configuration Table

Battery	Switch	1	2
Wet (lead acid)		ON	OFF
LM Wet (low maintenance)		ON	ON
AGM/Gel/Sealed		OFF	ON
Exide Gel		OFF	OFF

FIG. 37

To charge batteries:

- Transport the machine to a well-ventilated area.
- Park the machine on a flat, dry surface. Turn the key off and set the parking brake, if equipped.
- If charging wet (lead acid) batteries check the fluid level before charging (See BATTERY MAINTENANCE).
- Connect the charger's AC power supply cord into a properly grounded receptacle (Figure 38).

NOTE: The machine will not operate when charging.

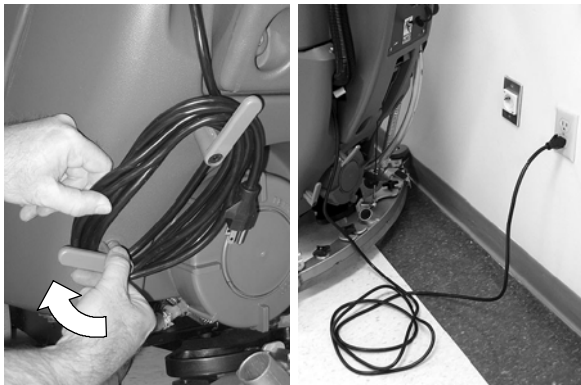

FIG. 38

- Once the charging cycle begins, the indicator lights will progress from red, yellow to green (Figure 39). When the green indicator light comes on, the charging cycle is done. Unplug the charger cord.

If the charger detects a problem, the charger will display an fault code (See ON-BOARD BATTERY CHARGER FAULT CODES).



FIG. 39



FIG. 40

- Prop up the recovery tank for ventilation (Figure 40).

ON-BOARD BATTERY CHARGER FAULT CODES

FAULT CODE	FAULT	SOLUTION
Yellow Light Flashing	Loose charger cable connection	Check charger cable connection
	Loose or damaged battery cable	Check battery cable connections
	Unsuitable battery	Replace with proper battery
	Output short circuit - damaged output cable	Contact Service Center
	Internal short circuit - blown output fuse	Replace battery charger
Red Light Flashing	Safety timer exceeded maximum charging time	Repeat charging cycle. If error repeats, replace batteries

MACHINE MAINTENANCE

To keep the machine in good working condition, simply follow the daily, monthly and quarterly maintenance procedures.

⚠ WARNING: Electrical Hazard. Disconnect Battery Cables Before Servicing Machine.

DAILY MAINTENANCE

1. Drain and clean out the recovery tank (Figure 41).



FIG. 41

2. Remove the debris tray and empty (Figure 42)

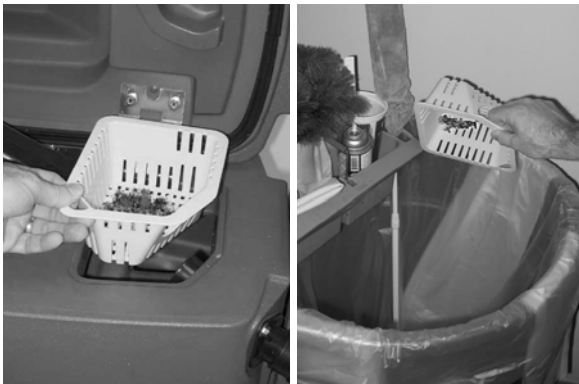

FIG. 42

3. Remove and clean the float shut-off screen located in the recovery tank (Figure 43).



FIG. 43

4. Drain the solution tank and rinse out the inside with water (60°C maximum) as needed (Figure 44)

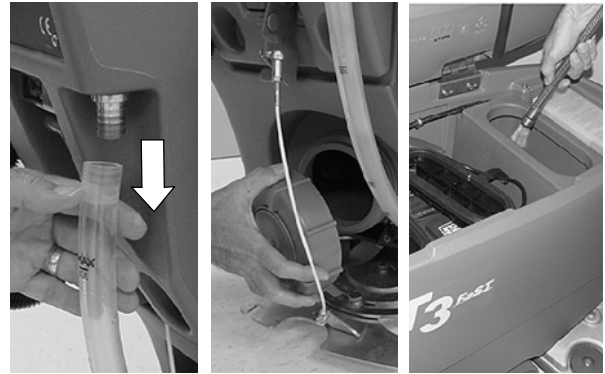

FIG. 44

5. Remove and clean the solution tank filter (Figure 45). Turn the filter counter-clockwise to remove.



FIG. 45

6. Remove the pad(s)/brush(es) and clean. Rotate pad or replace when worn (Figure 46).



FIG. 46

7. Wipe the squeegee blades clean. When machine is not in use, raise the squeegee assembly off the floor or hang it on the storage bracket (Figure 47).



FIG. 47

8. Check the condition of the squeegee blade wiping edge (Figure 48). Rotate blade if worn. (See SQUEEGEE BLADE REPLACEMENT)

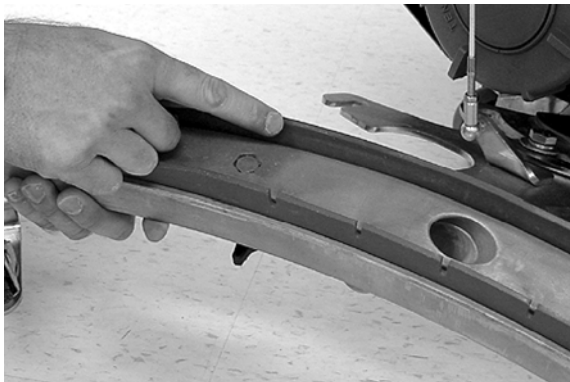

FIG. 48

9. Clean the machine with an all purpose cleaner and damp cloth (Figure 49).

FOR SAFETY: When cleaning machine, do not power spray or hose off machine. Electrical malfunction may occur.



FIG. 49

10. 43 cm Single Disk Model: Inspect the condition of the scrub head skirt, replace if worn or damaged (Figure 50).



FIG. 50

11. FaST Model: Connect the FaST-PAK supply hose to the storage plug when not in use (Figure 51). Remove any dried concentrate from the hose connector by soaking it in warm water.

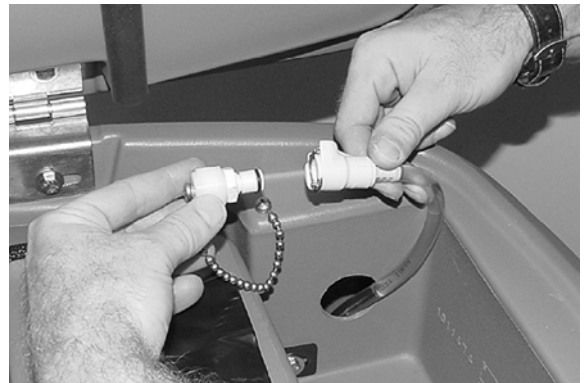

FIG. 51

12. Recharge the batteries after a total of 30 minutes of use or more (Figure 52). (See CHARGING BATTERIES).



FIG. 52

MONTHLY MAINTENANCE

1. Lead Acid Batteries: Clean the battery tops to prevent corrosion (See BATTERY MAINTENANCE).
2. Check for loose battery cable connections.
3. Inspect and clean the recovery tank cover seal (Figure 53). Replace if damaged.



FIG. 53

4. Lubricate all pivot points and rollers with silicone spray then coat with a water resistant grease to maintain smooth operation.
5. Clean the parking brake clamp with a cleaning solvent.
6. Check the machine for loose nuts and bolts.
7. Check the machine for leaks.

MOTOR MAINTENANCE

Contact an Authorized Tennant Service Center for carbon brush replacement.

Carbon Brush Replacement	Hours
Drive Transaxle Motor	750
Vacuum Motor	750
Brush Motor	750

⚠ WARNING: Electrical Hazard. Disconnect Battery Cables Before Servicing Machine.

FaST SYSTEM MAINTENANCE

Every 1000 hours replace the water filter and air filter located in the FaST detergent injector. Order filter kit p/n 9003009.

The detergent injector is located behind the front edge of the machine, held in place by two spring clamps.

1. Lower scrub head and remove the detergent injector from the two spring clamps (Figure 54).

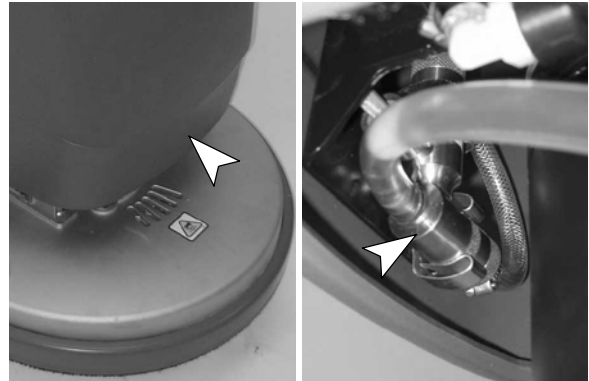

FIG. 54

2. Replace the water and air filter (Figure 55). An 8mm hex wrench is required to install new water filter.

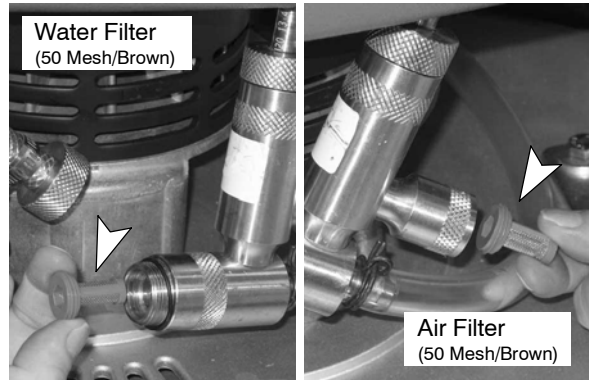

FIG. 55

ec-H2O MODULE FLUSH PROCEDURE

This procedure is only required when an alarm sounds and the ec-H2O system indicator light begins to blink red.

1. Drain the solution tank and recovery tank of all water.
2. Pour 1 gallon (4 liters) of white or rice vinegar into the solution tank at full strength. Do not dilute. (p/n 1050552 - Vinegar, 2.5 gals/10 ltrs)

NOTE: Use **white or rice vinegar** only. The acidity level should be between 4-8%. Do not use other acids for this procedure.

FOR SAFETY: When servicing machine, wear protective gloves and eye protection when handling vinegar.

3. Disconnect the black connector fitting at the scrub head and place the hose into a bucket (Figure 56).

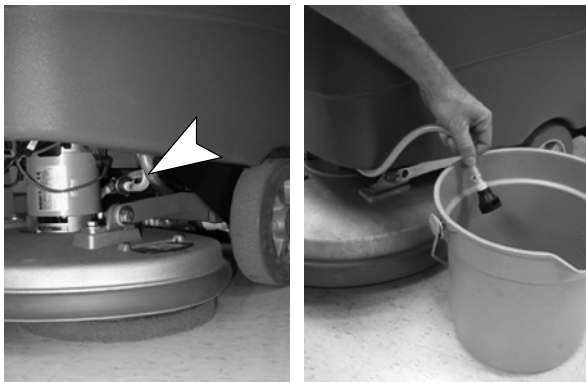

FIG. 56

4. Turn the key to the on (I) position.
5. Press and release the ec-H2O module flush switch to start the flush cycle (Figure 57). The module is located under the recovery tank.

NOTE: The module will automatically shut off when the flush cycle is complete (approx. 7 minutes). The module must run the full 7 minute cycle in order to reset the system indicator light and alarm.

Repeat flush procedure if the ec-H2O module does not reset. If module fails to reset, contact an Authorized Service Center.



FIG. 57

SQUEEGEE BLADE REPLACEMENT

Each squeegee blade has four wiping edges. When the blades become worn, simply rotate the blades end-for-end or top-to-bottom for a new wiping edge. Replace blade if all four edges are worn.

1. Remove the squeegee assembly from the machine.
2. Loosen the band clamp and remove the band from the squeegee assembly (Figure 58).

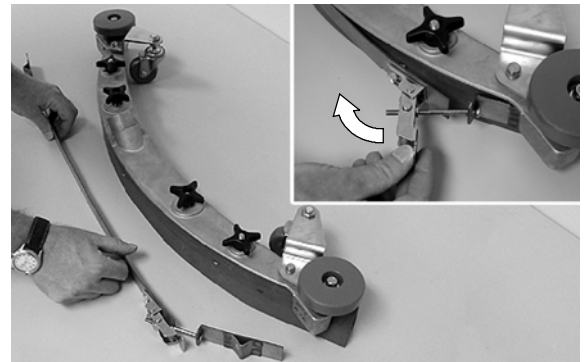

FIG. 58

3. Rotate the rear blade to a new wiping edge and reinstall the band. Make sure the notched edge of the band is facing downward (Figure 59).

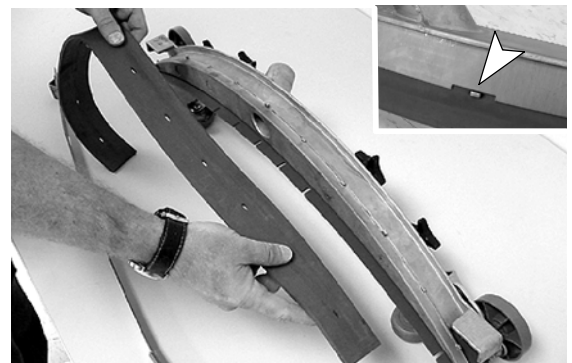

FIG. 59

4. To replace the front blade, remove the rear band and fully loosen the four squeegee assembly knobs, do not remove the knobs. Lift and tilt the retainer plate to access the front blade (Figure 60). Rotate the front blade to a new wiping edge and return the retainer plate. Make sure the retainer plate tabs engage the blade slots. Reinstall the band then retighten the knobs.

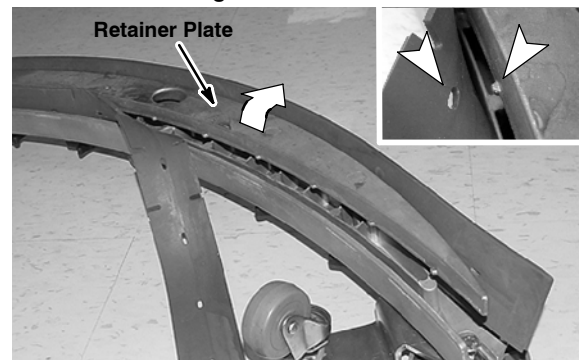

FIG. 60

SQUEEGEE BLADE ADJUSTMENT

For optimum squeegee blade performance, the squeegee assembly casters must be adjusted to a specified height as described below.

1. To check the squeegee assembly for proper adjustment, remove the squeegee assembly from the machine and place it on a level surface. Measure the distance between the caster and the surface. It should measure approximately 2 mm (Figure 61).
2. To adjust the caster height, loosen the top nut and remove the plastic bearing cover to access the adjustment nut. Turn the adjustment nut until properly adjusted (Figure 61). After adjusting, tighten the top nut and replace the plastic bearing cover. Repeat step for the other caster.

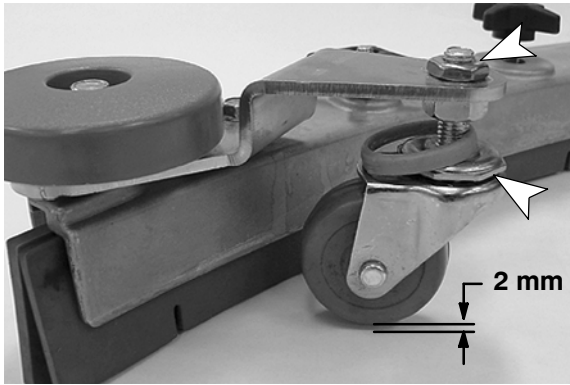

FIG. 61

3. During machine operation, with the casters properly adjusted, the squeegee blades should deflect as shown (Figure 62).

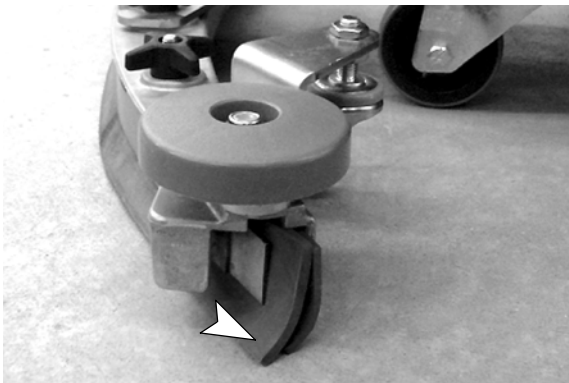
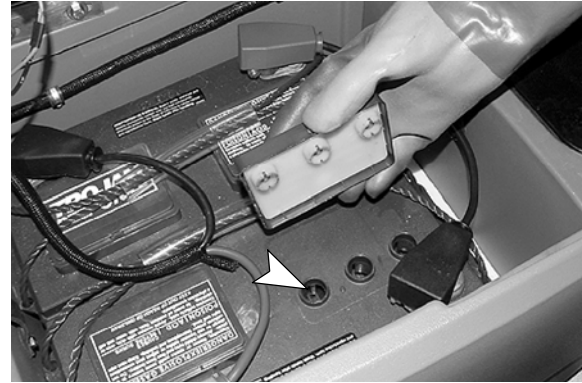

FIG. 62

BATTERY MAINTENANCE (Lead Acid Batteries)

1. Check battery fluid level frequently to prevent battery damage. The fluid should be at the level shown (Figure 63). Add distilled water if low. **DO NOT OVERFILL**, the fluid may expand and overflow when charging.



CORRECT BATTERY FLUID LEVEL:

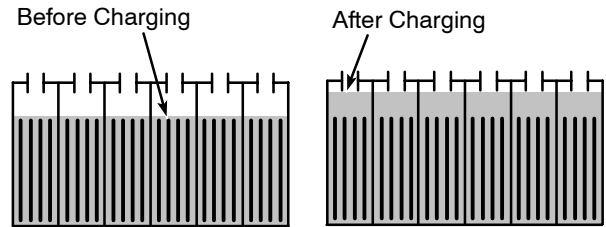

FIG. 63

⚠ WARNING: Fire Or Explosion Hazard. Batteries Emit Hydrogen Gas. Keep Sparks And Open Flame Away. Keep Battery Compartment Open When Charging.

2. Clean the batteries to prevent battery corrosion. Use a scrub brush with a mixture of baking soda and water (Figure 64).

FOR SAFETY: When cleaning batteries, wear protective gloves and eye protection. Avoid contact with battery acid.



FIG. 64

**BRUSH MOTOR BELT REPLACEMENT
(DUAL DISK MODELS)**

⚠ WARNING: Electrical Hazard. Disconnect Battery Cables Before Servicing Machine.

- Using a 13 mm wrench, disconnect the scrub head lift arms from the scrubhead mounting brackets as shown (Figure 65).

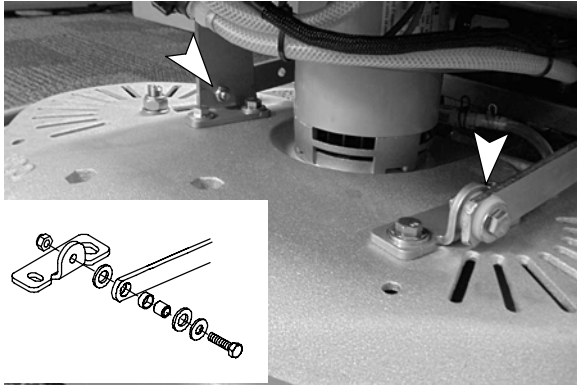

FIG. 65

- Unplug the brush motor wire connector and disconnect the solution feed hose (Figure 66).

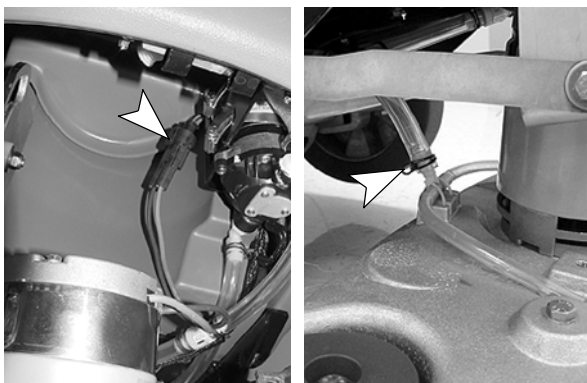

FIG. 66

- Remove the scrub head from the machine (Figure 67).



FIG. 67

- Carefully lay the scrub head bottom side up and remove the belt cover, 10 mm wrench required (Figure 68).

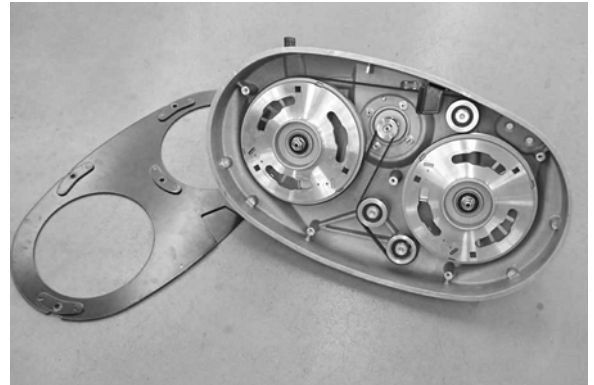

FIG. 68

- Route the new belt as shown (Figure 69).

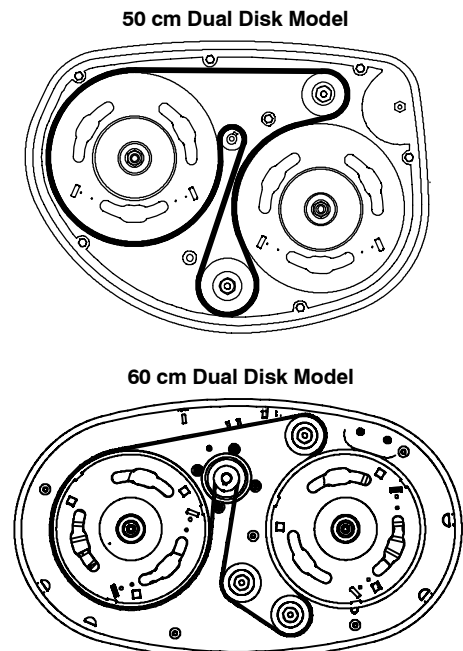

FIG. 69

- To install belt, use a socket driver ratchet with an extension and a large flathead screwdriver as shown. The hub driver is equipped with tool slots (Figure 70).

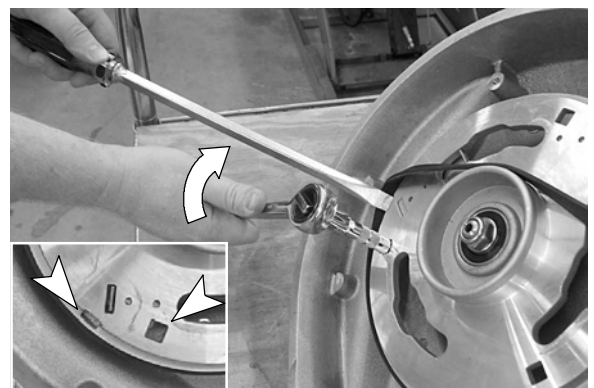

FIG. 70

50 cm Dual Disk Model Belt Replacment:
(S/N T3XXX12000 - T3xxx15475)

1. To replace the belt, completely loosen the belt tension bolt and install the new belt as shown (Figure 71). Match the groove side of the belt to the grooved pulleys.

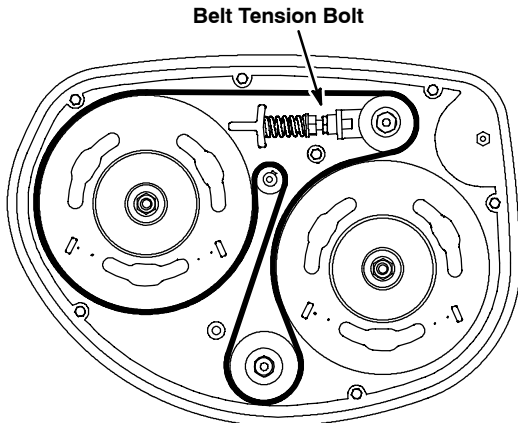

FIG. 71

2. To properly adjust the belt tension, turn the belt tension bolt until the tension spring is compressed to a length of 35mm (Figure 72). Tighten the tension bolt jam nut after adjusting.

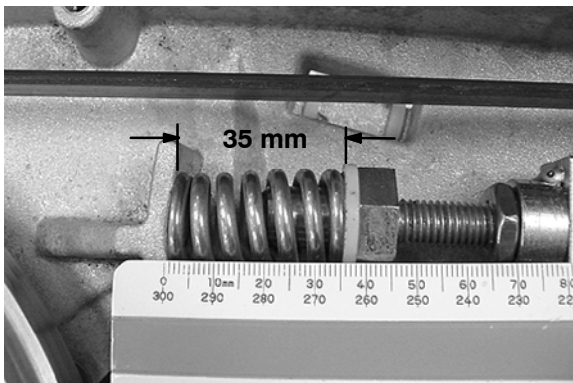

FIG. 72

3. After the first 50 hours of use, recheck the belt for proper tension.

TRANSPORTING MACHINE

When transporting the machine by use of trailer or truck, be certain to follow the tie-down procedure below:

1. Raise the squeegee and scrub head.
2. Load the machine using a recommended loading ramp.

3. Position the front of machine up against the front of the trailer or truck. Once the machine is positioned, lower the scrub head and squeegee.
4. Set the parking brake and place a block behind each wheel to prevent the machine from rolling.
5. Place tie-down straps over the top of machine to prevent it from tipping. It may be necessary to install tie-down brackets to the floor of your trailer or truck.

FOR SAFETY: When transporting machine, use a recommended ramp when loading/unloading into/off truck or trailer. Use tie-down straps to secure machine to truck or trailer.

STORING MACHINE

1. Charge the batteries before storing. Never store the machine with discharged batteries.
2. Drain and rinse the tanks thoroughly.
3. Store the machine in a dry area with the squeegee and scrub head in the up position.
4. Open the recovery tank cover to promote air circulation.

ATTENTION: Do not expose machine to rain, store indoors.

5. If storing machine in freezing temperatures, follow the FREEZE PROTECTION instructions below.

FREEZE PROTECTION

1. Drain the solution tank and recovery tank of all water.
2. Pour 1 gallon (4 liters) of recreational vehicle (RV) antifreeze into the solution tank at full strength. Do not dilute.

FOR SAFETY: Avoid eye contact with antifreeze. Wear safety glasses.

3. Turn the machine power on and operate the solution flow system. Turn the machine off when the red RV antifreeze is visible.

If your machine is equipped with the off-aisle wand option, operate the the off-aisle wand for a few seconds to protect the pump.

Continue with the freeze protection procedure if machine is equipped with the *ec-H2O* system.

ec-H2O Model: Press and release the flush switch on the *ec-H2O* module to cycle the antifreeze through *ec-H2O* system (Figure 73). When the antifreeze is visible, press the switch again to turn off the module.



FIG. 73

IMPORTANT: Before operating machine, the antifreeze must be flushed from the module as described below.

If the antifreeze is not properly flushed from the *ec-H2O* system, the *ec-H2O* module may detect an error and not function (*ec-H2O* switch indicator light will turn red). If this occurs, reset key and repeat the flush procedure as described below.

Flushing antifreeze from ec-H2O module:

1. Drain the antifreeze from the solution tank into a bucket.
2. Fill the solution tank with cool water until full (See FILLING SOLUTION TANK).
3. Disconnect the black connector fitting at the scrub head and place the hose into a bucket (Figure 74). To access the connector fitting, you may have to remove the front cover from the machine.

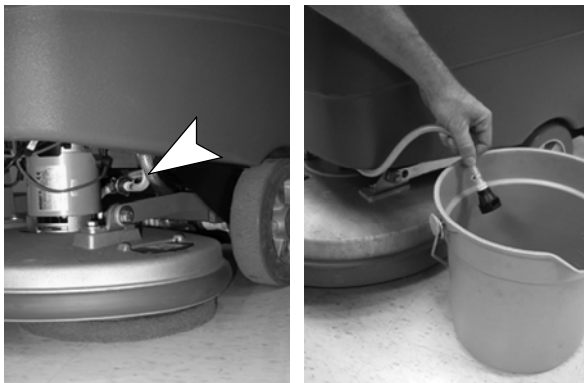

FIG. 74

4. Press and release the *ec-H2O* module switch to flush the antifreeze from the *ec-H2O* system (Figure 73). The module is located under the recovery tank.

When the water turns clear, press the module switch again to stop the flush cycle.

Dispose the antifreeze in an environmentally safe way according to local waste disposal regulations.

5. The machine is now ready for scrubbing.

RECOMMENDED STOCK ITEMS

Refer to the Parts List Manual for recommended stock items. Stock Items are clearly identified with a bullet preceding the parts description. See example below:

26	1017380	(00000000-) • Hose, Drain, Assy, 1.5d X 29.5l, Blk, Fix
27	1008639	(00000000-) • Drain Assy
28	1019563	(00000000-) • Strap, Drain Cap
29	1008637	(00000000-) • O Ring, 1.48" Id, 1.76" Od

TROUBLESHOOTING

PROBLEM	CAUSE	SOLUTION
Machine will not operate	Discharged batteries	Charge batteries
	Emergency-stop button activated	Turn button clockwise to reset
	Faulty battery(s)	Replace battery(s)
	Loose battery cable	Tighten loose cable
	Main fuse blown	Replace fuse
	Faulty key switch	Contact Service Center
Battery Meter is flashing (Drive Model)	Machine fault has been detected	See BATTERY METER LED FAULT CODES
On-board battery charger will not operate	Plug not connected to power supply	Check plug connection
	Faulty power supply cord	Replace cord
	Fault detected.	See ON-BOARD BATTERY CHARGER FAULT CODES
Brush motor will not operate	Scrub head is raised off floor	Lower scrub head
	Battery meter lockout activated	Recharge batteries
	Tripped brush motor circuit breaker	Reset brush circuit breaker button
	Faulty scrub head (up/down) switch	Contact Service Center
	Faulty Control handle bail switch	Contact Service Center
	Faulty brush motor or wiring	Contact Service Center
	Worn carbon brushes	Contact Service Center
	Broken or loose belt (50cm/60cm models)	Replace or tighten belt
Machine does not propel (50cm / 60cm Dual Disk model with drive)	Parking brake is set	Release parking brake lever
	Main fuse blown	Replace 30 Amp fuse
	Faulty relay switch	Contact Service Center
	Faulty transaxle motor or wiring	Contact Service Center
	Worn carbon brushes	Contact Service Center
Vacuum motor will not operate	Squeegee is raised off floor	Lower squeegee
	Vacuum motor fuse blown	Replace 25 Amp fuse
	Faulty vacuum motor or wiring	Contact Service Center
	Worn carbon brushes	Contact Service Center
FaST Model: FaST System does not operate or operate correctly	FaST system switch is not turned on	Turn on FaST system switch
	FaST-PAK supply hose not connected	Connect supply hose
	FaST Pump fuse blown	Replace 7.5 Amp fuse
	Clogged FaST-PAK supply hose or connectors	Soak in warm water to unclog
	Empty FaST-PAK carton	Replace FaST PAK carton
	Kink in FaST-PAK supply hose	Undo hose kink
	Clogged FaST solution system	Contact Service Center
	Faulty FaST system on/off switch	Contact Service Center
	Faulty pump	Contact Service Center
Clogged solution tank filter	Drain solution tank. remove solution tank filter, clean and reinstall	

TROUBLESHOOTING - Continued

PROBLEM	CAUSE	SOLUTION
FaST Model: FaST System does not operate or operate correctly	Clogged detergent injector	See FaST SYSTEM MAINTENANCE
Little or no solution flow (Conventional Scrubbing)	Clogged solution tank filter or solution hose	Clean solution tank filter or flush out solution hose
	Clogged solution valve	Remove valve and clean
	Solution flow control knob set too low	Adjust solution control flow knob
	Loose screw on control knob	Calibrate knob and retighten screw
Poor water pickup	Recovery tank is full	Drain recovery tank
	Loose drain hose cap	Tighten cap
	Clogged float shut-off screen located in recovery tank	Clean screen
	Clogged squeegee assembly	Clean squeegee assembly
	Worn squeegee blades	Replace or rotate squeegee blades
	Incorrect Squeegee blade deflection	Adjust Squeegee blade height
	Loose vacuum hose connections	Secure hose connections
	Clogged vacuum hose	Remove clogged debris
	Damaged vacuum hose	Replace vacuum hose
	Recovery tank cover not in place	Properly position cover
	Damaged recovery tank cover seal	Replace seal
	Faulty vacuum motor	Contact Service Center
	Low battery charge	Recharge batteries.
Short run time	Batteries not fully charged	Fully recharge batteries
	Defective batteries	Replace battery
	Service batteries	See BATTERY MAINTENANCE
	Faulty battery charger	Repair or replace battery charger
	Down pressure lever is set for extra scrub head pressure	Lower down pressure lever
ec-H2O Model: <i>ec-H2O</i> system indicator light blinks red and alarm sounds	Mineral deposit build-up in module	Flush module (See <i>ec-H2O</i> MODULE FLUSH PROCEDURE). If indicator light starts flashing within 1-10 seconds, repeat flush procedure. If indicator light starts flashing after a minute of scrubbing, the water may have low conductivity.
	Low water conductivity	Add 8 ml of salt to every 40 L of water.
ec-H2O Model: <i>ec-H2O</i> system indicator light solid red	Defective module	Contact Service Center
ec-H2O Model: <i>ec-H2O</i> system indicator light does not turn on	Defective light or module	Contact Service Center
ec-H2O Model: No water flow	Clogged module	Contact Service Center
	Defective solution pump	Replace solution pump

BATTERY METER LED FAULT CODES (Drive Model)

CODE (Flashing LED Bars)	FAULT	SOLUTION
One	Low voltage shut-off.	Recharge batteries.
	Scrubbing function stops.	Check battery connection.
Two	Battery charge level getting low.	Recharge batteries.
Three	Drive motor tripped.	Remove overload condition and reset key.
	Short circuit to drive motor.	Contact Service Center.
Four	Battery lockout.	Recharge batteries immediately.
Eight	Controller tripped.	Contact Service Center.
Ten	High battery voltage reading	Check battery connections.
No Bars	Sleep mode	Turn key to restore.
Bars Rippling	Throttle engaged.	Release activation bail.

SPECIFICATIONS

MODEL	T3 43 cm Single Disk	T3 50 cm Dual Disk	T3+ 60 cm Dual Disk
LENGTH	1128 mm	1167 mm	1225 mm
WIDTH	486 mm	517 mm	560 mm
HEIGHT	1090 mm	1090 mm	1090 mm
WEIGHT / with BATTERIES	100 Kg / 143 Kg	101 Kg / 144 Kg	101 Kg / 177 Kg
RECOVERY TANK CAPACITY	40 L	40 L	40 L
SOLUTION TANK CAPACITY	40 L	40 L	40 L
DRIVE SYSTEM	N/A	24 V, 0.104 Kw	24 V, 0.104 Kw
PRODUCTIVITY RATE - AVG.	1045 m ² per hour (FaST)	1691 m ² per hour (FaST)	2007 m ² per hour (ec-H ₂ O)
	785 m ² per hour	1492m ² per hour	
CLEANING PATH WIDTH	430 mm	500 mm	600 mm
PAD PRESSURE	18.9 Kg	18.59 Kg	23/41 Kg
SQUEEGEE WIDTH	760 mm	760 mm	760 mm
BRUSH MOTOR	0.373 Kw, 220 rpm, 24 V, 20 A	0.224 Kw, 260 rpm, 24 V, 12 A	0.65 Kw, 285 rpm, 24 V, 33 A
VACUUM MOTOR	350 W, 2-stage 5.7, 24 V, 13 A	350W, 2-stage 5.7, 24 V, 13 A	350W, 2-stage 5.7, 24 V, 13 A
WATER LIFT	100 Mbar	100 Mbar	100 Mbar
BATTERIES	Two - 12 V	Two - 12 V	Two - 12 V
ON-BOARD BATTERY CHARGER	230 VAC, 5.5 A, 50/60 Hz, 24 VDC, 13 A output		
RUN TIME PER CHARGE	Up to 2.5 hours	Up to 3.25 hours	Up to 3 hours
TOTAL POWER CONSUMPTION	32 Amp nominal	28 Amp nominal	29 Amp nominal
VOLTAGE DC	24 VDC	24 VDC	24 VDC
BATTERY CAPACITY	110 Ah / 5hr Rate	110 Ah / 5hr Rate	125 Ah / 5hr Rate
PROTECTION GRADE	IPX3	IPX3	IPX3
SOUND POWER LEVEL	68 dB (1m x 1m)	68 dB (1m x 1m)	68 dB (1m x 1m)
DECIBEL RATING AT OPERATOR'S EAR, INDOORS.	68.5 dB(A)	68.5 dB(A)	68.5 dB(A)
VIBRATIONS AT HAND CONTROLS	<2.5m/s ²	<2.5m/s ²	<2.5m/s ²
MAXIMUM GRADE LEVEL	8% (5°) Transporting 5% (3°) Cleaning	8% (5°) Transporting 5% (3°) Cleaning	8% (5°) Transporting 5% (3°) Cleaning

FaST SYSTEM - FaST MODEL	
SOLUTION PUMP	24 Volt DC, 3.5 A, 5.6 LPM open flow, 4.13 Bar bypass setting
SOLUTION FLOW RATE	0.47 LPM
CONCENTRATE FLOW RATE	0.47 CC/Minute
CONCENTRATE TO WATER DILUTION RATIO	1:1000

ec-H₂O SYSTEM - ec-H₂O MODEL			
SOLUTION PUMP	24 Volt DC, 3.5 A, 5.6 LPM open flow, 4.13 Bar bypass setting		
SOLUTION FLOW RATE	0.47 L/min (standard)	0.47 L/min (standard)	0.57 L/min (standard)
	0.72 L/min (optional)	0.72 L/min (optional)	0.76 L/min (optional)
	0.95 L/min (optional)	0.95 L/min (optional)	0.95 L/min (optional)

* If the optional solution flow rates are required, contact an Authorized Service Center.

MACHINE DIMENSIONS

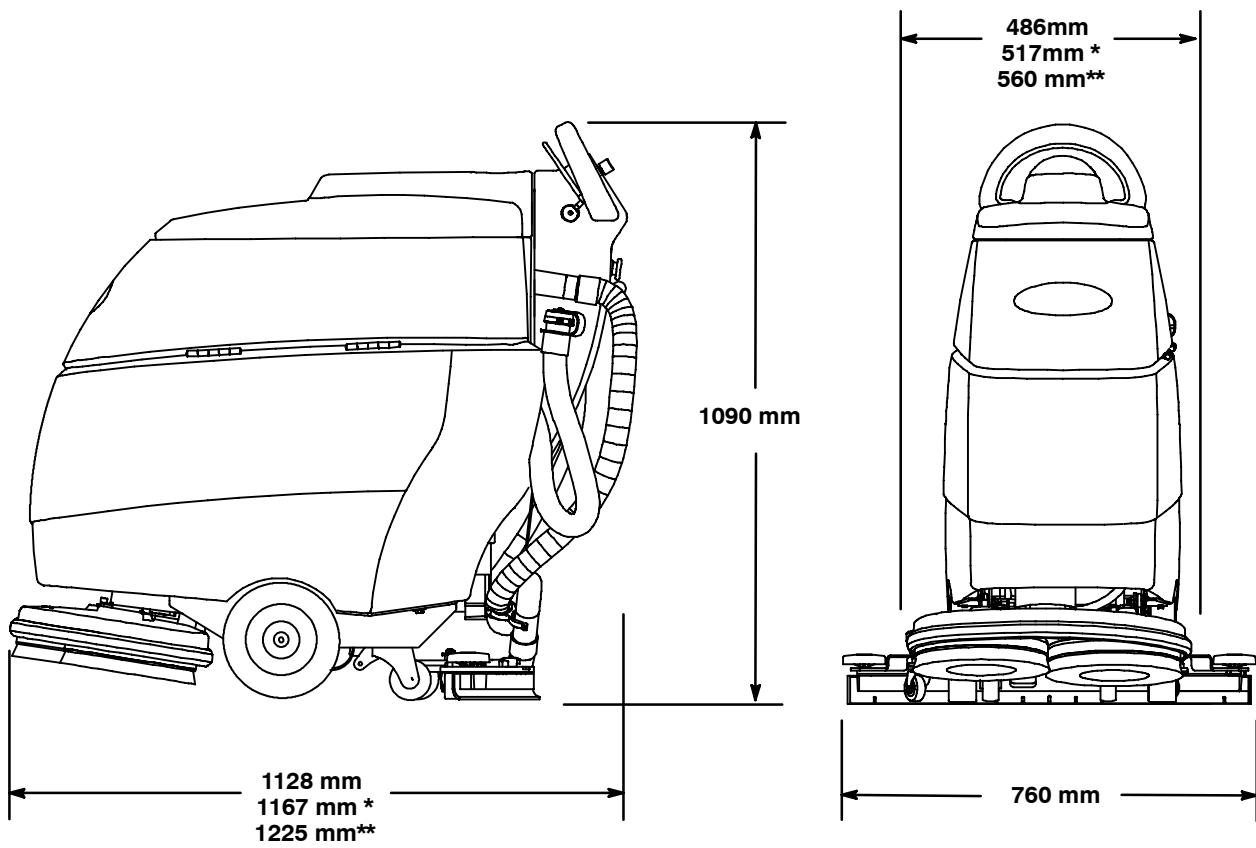

* 50 cm Dual Disk Model

** 60 cm Dual Disk Model